

AA-55 ZOOM

AA-55 ZOOM

Antenna and cable analyzers

RigExpert®

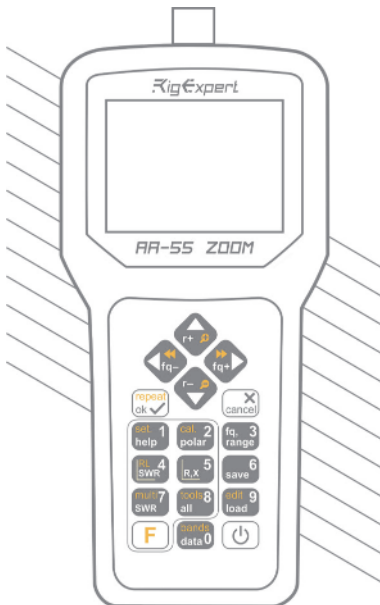

User's manual

For latest manuals and software updates,
please visit

<http://rigexpert.com>

Table of contents

| | |
|---------------------------------------|-----------|
| Introduction | 4 |
| Operating the AA-55 ZOOM | 5 |
| First time use | 5 |
| Main menu | 5 |
| Multifunctional keys | 6 |
| Connecting to your antenna | 6 |
| SWR chart | 7 |
| Chart ZOOM | 7 |
| Data screen | 8 |
| Frequency and range entry | 8 |
| Return loss chart | 8 |
| R,X chart | 9 |
| Smith chart | 9 |
| Memory operation | 10 |
| SWR mode | 10 |
| Display all parameters | 11 |
| MultiSWR mode | 12 |
| Applications | 13 |
| Antennas | 13 |
| Coaxial lines | 14 |
| Measurement of other elements | 21 |
| Annexes | 24 |
| Annex 1: Specifications | 24 |
| Annex 2: Precautions | 25 |
| Annex 3: Tools menu | 26 |
| Annex 4: Setup menu | 31 |
| Annex 5: Calibration | 32 |
| Annex 6: Dummy loads | 34 |

Introduction

Thank you for purchasing a **RigExpert AA-55 ZOOM** Antenna and Cable Analyzer! We did our best to make it powerful yet easy to use.

The analyzer is designed for measuring SWR (standing wave ratio), return loss, cable loss, as well as other parameters of cable and antenna systems in the range of 60 kHz to 55 MHz. A built-in ZOOM capability makes graphical measurements especially effective.

The following tasks are easily accomplished by using this analyzer:

- Rapid check-out of an antenna
- Tuning an antenna to resonance
- Comparing characteristics of an antenna before and after specific event (rain, hurricane, etc.)
- Making coaxial stubs or measuring their parameters
- Cable testing, measuring cable loss and characteristic impedance
- Measuring capacitance or inductance of reactive loads

4



1. Antenna connector
2. Liquid crystal display
3. Keypad
4. USB connector

Operating the AA-55 ZOOM

First time use

Please insert two AA batteries (only alkaline or Ni-MH ones) into the battery compartment of the analyzer, watching the polarity.

Instead, you may power it from a spare USB port of your computer by using a conventional USB cable.

Press the  (Power) key located at the bottom-right corner of the keypad to turn on the analyzer. After displaying the initial message (showing a firmware version and a serial number of the instrument), a **Main menu** appears on the screen.





Do not use Li-ion or other batteries with voltage more than 1.5 V.

The analyzer will be turned off automatically if not in use for too long.

Main menu

The Main menu acts as a starting point from where different tasks may be launched.

Use  (Cursor up) and  (Cursor down) keys to scroll through the menu, then press  (OK) to select an item.

For your convenience, a battery indicator is shown at the top-left corner of the screen. This indicator is replaced with a USB icon when the analyzer is connected to your computer.

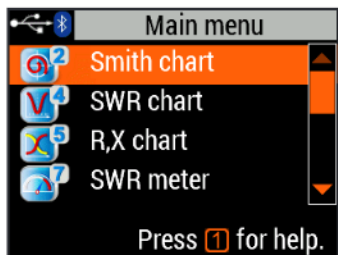

*You may use hot keys for the quick access to certain tasks. For instance, press the **4** (SWR chart) button to open the SWR chart screen immediately.*

Multifunctional keys

Most keys on the analyzer's keypad perform several functions.

For instance, numbers (1) are used to enter frequency and other numerical parameters. Main functions (2) provide quick access to most common tasks. Alternative functions (3) are executed if the user holds the **F** (Functional) key. For the convenience, alternative functions are marked with yellow.

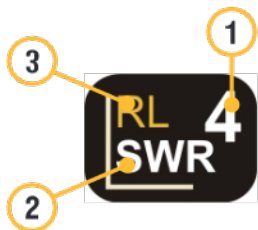

You may press the **1** (Help) key to open a help screen listing all active hot keys.

Connecting to your antenna

Plug the cable to your analyzer's antenna connector, and then tighten the rotating sleeve. The rest of the connector, as well as the cable, should remain stationary.

If you twist other parts of the connector when tightening or loosening, damage may easily occur. Twisting is not allowed by design of the UHF-connector.

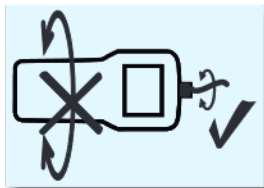

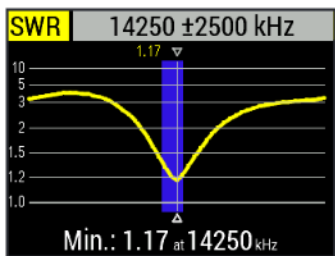

SWR chart

Once your antenna is connected to the analyzer, it is time to measure its characteristics. Press the **4** (SWR chart) key to open the SWR chart screen, then press (OK) to start a new measurement.

A few moments later, the result will be displayed on the analyzer's screen.

Press the **F** + key combination to run a continuous sweep.

A small triangle at the bottom of the chart corresponds to a point at which the SWR reaches its minimum.

Chart ZOOM

Use the arrow keys to increase or decrease the center frequency or the scanning range. Watch the chart zooming in or out, or changing its position. Use the **F** (Functional key) and (Cursor up) or (Cursor down) key combination to zoom the vertical scale of the chart.

Do not forget to press the (OK) key for the new measurement to start.

*Press **F** (Functional key) and **0** to quickly choose a radio amateur band.*

Data screen

The data screen is available in all chart modes. Press the **0** (Data) key to display various parameters of a load at cursor.

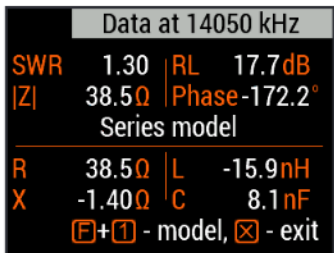

Frequency and range entry

To enter the center frequency or the sweep range, press the **3** (Frequency, Range) key.

Use cursor keys to navigate, or the **0** to **9** keys to enter values. Do not forget to press the (OK) key to apply.

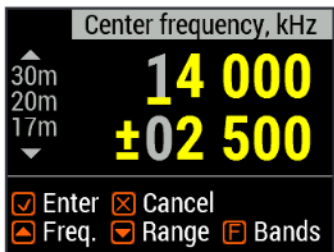

Press (Up) or (Down) cursor keys while holding the (Functional) key to quickly choose a radio amateur band.

Return loss chart

The return loss (RL) chart, which is very similar to the SWR chart, is activated by pressing the (Functional key) and **4** (RL chart) key combination in the Main menu.

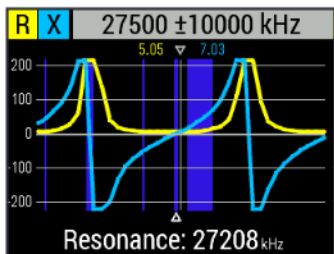

R,X chart

Press the **5** (R,X chart) key in the **Main menu** to access the **R,X chart** mode.

Positive values of reactance (X) correspond to inductive load, while negative values correspond to capacitive load.

The chart will display **R** and **X** for series or parallel models of a load. Press **F** (Functional key) and **1** to switch between these models.

The marker at the bottom of the screen shows a resonant frequency closest to the center of the scan.

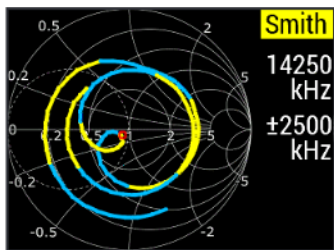

Smith chart

The **2** (Smith chart) key opens a screen where the reflection coefficient is plotted on the **Smith chart**.

For a list of hot keys, press the **1** (Help) key, as usual.

A small marker is used to indicate the center frequency.

Memory operation

Press the **6** (Save) key to save the chart into one of 10 available memory slots.

To retrieve your readings from the memory, press then **9** (Load) key, select a memory slot number and press (OK).

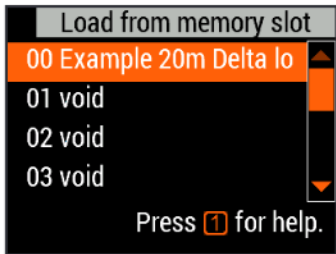

To rename any existing memory slot, press **F** (Functional key) and **9** (Edit) key combination.

SWR mode

To watch the SWR at a single frequency, press the **7** (SWR) key.

Do not forget to press the (OK) key to start or stop the measurement. Change the frequency with **◀** (Left) or **▶** (Right) cursor keys, or press the **3** (Frequency) key to enter a new frequency.

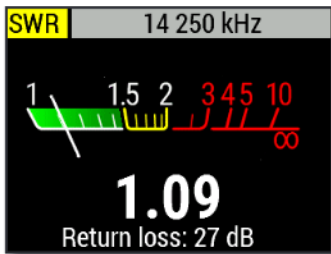

The SWR icon in the top-left corner flashes when the measurement is performed.

Display all parameters

To display various parameters of a load on a single screen, press the **8** (All) key.

| | | |
|---------------------------|------------|----------------------|
| All | 14 250 kHz | |
| SWR | 1.27 | RL 18.6dB |
| Z | 43.9Ω | Phase -123.8° |
| Series model | | |
| R | 43.1Ω | L -95.7nH |
| X | -8.56Ω | C 1.3nF |
| ☑ - start/stop, 1 - help. | | |

Do not be confused by negative values of L or C. This can be useful for experienced users.

This screen displays values for *series* as well as *parallel* models of impedance of a load.

- In the *series* model, impedance is expressed as resistance and reactance connected in series:
- In the *parallel* model, impedance is expressed as resistance and reactance connected in parallel:

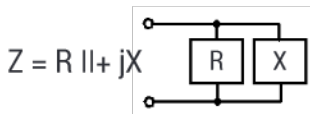
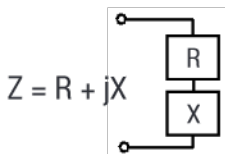

MultiSWR mode

Press the **F** (Functional key) and **7** (Multi) key combination to see the SWR at up to five different frequencies. This mode may be useful for tuning multi-band antennas.

| SWR | MultiSWR | |
|-----------|----------|--|
| 14175 kHz | 1.11 | |
| 18118 kHz | 1.92 | |
| 21225 kHz | 1.94 | |
| 24940 kHz | 1.05 | |
| 28850 kHz | 1.91 | |

Press **1** for help.

Use **▲** (Up) and **▼** (Down) cursor keys to select a frequency to be set or changed, then press the **3** (Frequency) key to enter a new value. Do not forget to press the **✓** (OK) key to start the measurement.

Press **F** (Functional key) and **▲** (Up) to see mini SWR graphs for each band.

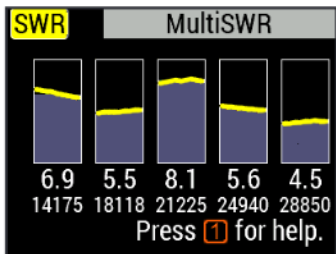

Antennas

Checking the antenna

It is a good idea to check an antenna before connecting it to the receiving or transmitting equipment. The **SWR chart** mode is good for this purpose.

The picture on the left shows the SWR chart of a HF antenna. The operating frequency is 14.25 MHz. The SWR at this frequency is 1.17, which is acceptable.

The next screen shot shows SWR chart of another antenna. The actual resonant frequency is 16 MHz, which is too far from the desired one. The SWR at 14.25 MHz is 2.49, which is not acceptable in most cases.

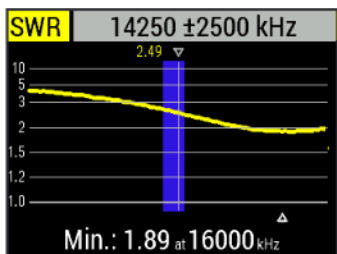
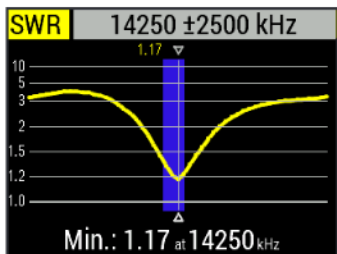

Adjusting the antenna

When the measurement diagnoses that the antenna is off the desired frequency, the analyzer can help in adjusting it. Physical dimensions of a simple antenna (such as a dipole) can be adjusted knowing the actual resonant frequency and the desired one. Other types of antennas may contain more than one element to adjust (including coils, filters, etc.), so this method will not work. Instead, you may use the **SWR mode**, the **All parameters mode** or the **Smith chart mode** to continuously see the results while adjusting various parameters of the antenna.

For multi-band antennas, use the **MultiSWR mode**. You can easily see how changing one of the adjustment elements (trimming capacitor, coil, or physical length of an aerial) affects SWR at up to five different frequencies.

Coaxial lines

Open- and short-circuited cables

The pictures on the right show **R** and **X** charts for a piece of cable with open- and short-circuited far end. A *resonant frequency* is a point at which X (reactance) equals to zero:

- In the open-circuited case, resonant frequencies correspond to (left to right) 1/4, 3/4, 5/4, etc. of the wavelength in this cable;
- For the short-circuited cable, these points are located at 1/2, 1, 3/2, etc. of the wavelength.

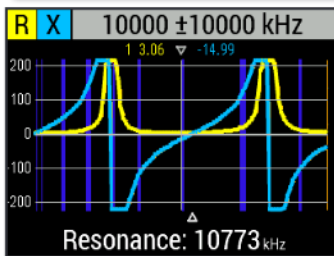
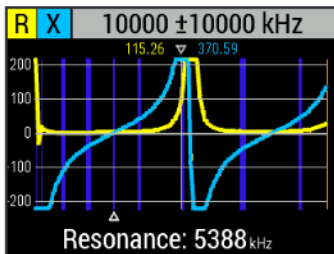

Cable length measurement

Resonant frequencies of a cable depend on its length as well as on the velocity factor.

A *velocity factor* is a parameter which characterizes the slowdown of the speed of the wave in the cable compared to vacuum. The speed of wave (or light) in vacuum is known as the *electromagnetic constant*: $c=299,792,458$ meters (or **983,571,056 feet**) per second.

Each type of cable has different velocity factor: for instance, for RG-58 it is 0.66. Notice that this parameter may vary depending on the manufacturing process and materials the cable is made of.

To measure the physical length of a cable,

1. Locate a resonant frequency by using the **R,X** chart.



2. Knowing the *electromagnetic constant* and the *velocity factor* of the particular type of cable, find the speed of electromagnetic wave in this cable.

Example:

The 1/4-wave resonant frequency of a piece of open-circuited RG-58 cable is 5381 kHz.

$$299,792,458 \times 0.66 = \\ 197,863,022 \text{ meters per second}$$

- or -

$$983,571,056 \times 0.66 = \\ 649,156,897 \text{ feet per second}$$

3. Calculate the physical length of the cable by dividing the above speed by the resonant frequency (in Hz) and multiplying the result by the number which corresponds to the location of this resonant frequency (1/4, 1/2, 3/4, 1, 5/4, etc.)

$$197,863,022 / 5,381,000 \times (1/4) = 9.19 \text{ meters}$$

- or -

$$649,156,897 / 5,381,000 \times (1/4) = 30.16 \text{ feet}$$

Velocity factor measurement

For a known *resonant frequency* and physical length of a cable, the actual value of the *velocity factor* can be easily measured:

1. Locate a *resonant frequency* as described above.

Example:

5 meters (16.4 feet) of open-circuited cable. Resonant frequency is 9400 kHz at the 1/4-wave point.

2. Calculate the speed of electromagnetic wave in this cable. Divide the length by 1/4, 1/2, 3/4, etc. (depending on the location of the resonant frequency), then multiply by the resonant frequency (in Hz).

$$5 / (1/4) \times 9,400,000 = 188,000,000 \text{ meters per second}$$

- or -

$$16.4 / (1/4) \times 9,400,000 = 616,640,000 \text{ feet per second}$$

3. Finally, find the *velocity factor*. Just divide the above speed by the electromagnetic constant.

$$188,000,000 / 299,792,458 = 0.63$$

- or -

$$616,640,000 / 983,571,056 = 0.63$$

Cable fault location

To locate the position of a probable fault in a cable, just use the same method as when measuring its length. Watch the behavior of the reactive component (X) near the zero frequency:

- If the value of X is moving from $-\infty$ to 0, the cable is open-circuited:

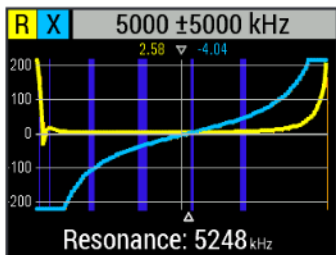

- If the value of X is moving from 0 to $+\infty$, the cable is short-circuited:

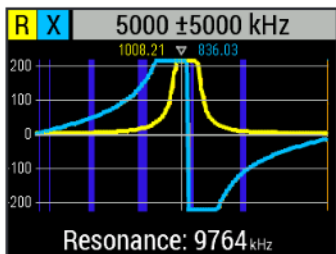

Making 1/4-λ, 1/2-λ and other coaxial stubs

Pieces of cable of certain electrical length are often used as components of *baluns* (balancing units), transmission line transformers or delay lines. To make a stub of the predetermined electrical length,

1. Calculate the physical length. Divide the electromagnetic constant by the required frequency (in Hz). Multiply the result by the velocity factor of the cable, then multiply by the desired ratio (in respect to λ).
2. Cut a piece of cable slightly longer than this value. Connect it to the analyzer. The cable must be open-circuited at the far end for 1/4-λ, 3/4-λ, etc. stubs, and short-circuited for 1/2-λ, λ, 3/2-λ, etc. ones.
3. Switch the analyzer to the **All parameters** measurement mode. Set the frequency the stub is designed for.
4. Cut little pieces (1/10 to 1/5 of the margin) from the far end of the cable until the **X** value falls to zero (or changes its sign). Do not forget to restore the open-circuit, if needed.

Example:

1/4-λ stub for 28.2 MHz, cable is RG-58 (velocity factor is 0.66)

$$299,792,458 / 28,200,000 \times 0.66 \times (1/4) = 1.75 \text{ meters}$$

- or -

$$983,571,056 / 28,200,000 \times 0.66 \times (1/4) = 5.75 \text{ feet}$$

A piece of 1.85 m (6.07 ft) was cut. The margin is 10 cm (0.33 ft). The cable is open-circuited at the far end.

28,200 kHz was set.

11 cm (0.36 ft) were cut off.

Measuring the characteristic impedance

The *characteristic impedance* is one of the main parameters of any coaxial cable. Usually, its value is printed on the cable by the manufacturer. However, in certain cases the exact value of the characteristic impedance is unknown or is in question.

To measure the characteristic impedance of a cable,

1. Connect a non-inductive resistor to the far end of the cable. The exact value of this resistor is not important. However, it is recommended to use 50 to 100 Ohm resistors.

2. Enter the **R,X chart** mode and make measurement in a reasonably large frequency range (for instance, 0 to 55 MHz).

Example 1: 50-Ohm cable with 100 Ohm resistor at the far end.

Example 2: Unknown cable with 100 Ohm resistor at the far end.

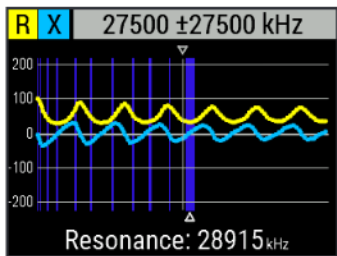

*Example 1:
50-Ohm cable*

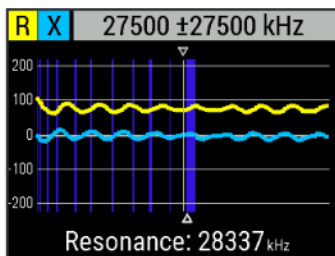

*Example 2:
Unknown cable*

3. Changing the display range and performing additional scans, find a frequency where **R** (resistance) reaches its maximum, and another frequency with minimum. At these points, **X** (reactance) will cross the zero line.

4. Switch to the **Data at cursor** screen by pressing the **0** (Data) key and find values of **R** at previously found frequencies.

5. Calculate the square root of the product of these two values.

Example 1:

3.85 MHz – min., 8.25 MHz – max.

Example 2:

5.50 MHz – max., 2.75MHz – min.

Example 1:

28.4 Ohm – min., 88.4 Ohm – max.

Example 2:

90.0 Ohm – max, 61.3 Ohm – min.

Example 1:

square root of $(28.4 \times 88.4) =$

50.1 Ohm

Example 2:

square root of $(90.0 \times 61.3) =$

74.3 Ohm

The Tools menu (see page 26) contains several automated tools for coaxial line calculations.

Measurement of other elements

Although RigExpert AA-55 ZOOM is designed for use with antennas and antenna-feeder paths, it may be successfully used to measure parameters of other RF elements.

Capacitors and inductors

The analyzer can measure capacitance from a few pF to about 0.1 μF as well as inductance from a few nH to about 100 μH . Since measuring of capacitance and inductance is not a main purpose of RigExpert analyzers, the user will have to gain some experience in such measurements.

Be sure to place the capacitor or the inductor as close as possible to the RF connector of the analyzer.

1. Enter the **R,X chart** mode and select a reasonably large scanning range. Perform a scan.

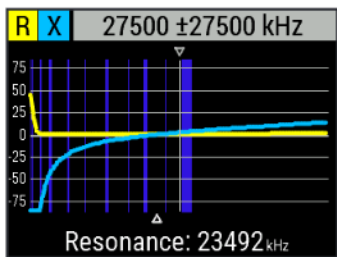

*Example 1:
Unknown capacitor*

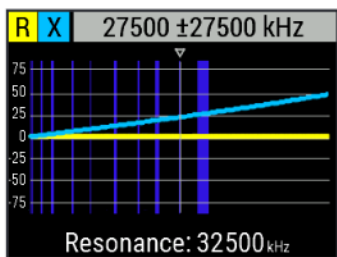

*Example 2:
Unknown inductor*

2. By using left and right arrow keys, scroll to the frequency where X is -25...-100 Ohm for capacitors or 25...100 Ohm for inductors. Change the scanning range and perform additional scans, if needed.

3. Switch to the **Data at cursor** screen by pressing the **0** key and read the value of capacitance or inductance.

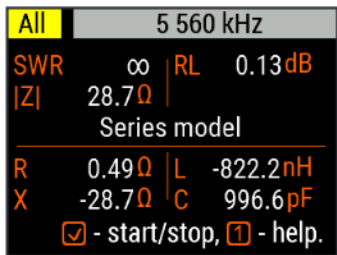

*Example 1:
Unknown capacitor*

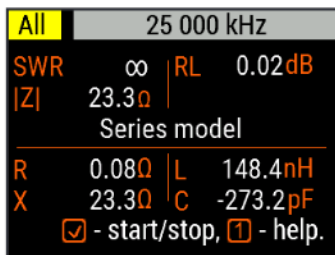

*Example 2:
Unknown inductor*

Transformers

RigExpert analyzers can also be used for checking RF transformers. Connect a 50 Ohm resistor to the secondary coil (for 1:1 transformers) and use **SWR chart**, **R,X chart** or **Smith chart** modes to check the frequency response of the transformer. Similarly, use resistors with other values for non-1:1 transformers.

Traps

A *trap* is usually a resonant L-C network used in multi-band antennas. By using a simple one-turn wire coil, a resonant frequency of a trap may be measured.

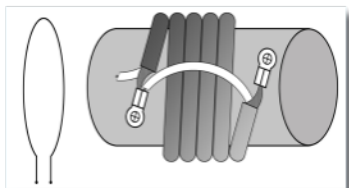

Example:

A coaxial trap constructed of 5 turns of TV cable (coil diameter is 6 cm) was measured.

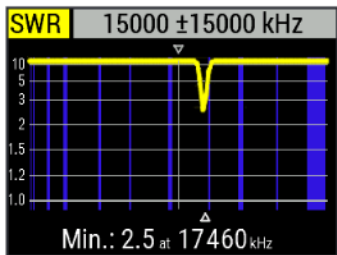

A one-turn coil (about 10 cm in diameter) connected to the analyzer was placed, co-axially, a few centimeters away from the measured trap. The SWR chart shows a visible dip at 17.46 MHz, which is a resonant frequency of the trap.

Annex 1

Specifications

Frequency range: 0.06 to 55 MHz

Frequency entry: 1 kHz resolution

Measurement for 25, 50, 75, 100, 150, 200, 300, 450, and 600-Ohm systems

SWR measurement range:

- 1 to 100 in numerical modes
- 1 to 10 in chart modes

SWR display: numerical or analog indicator

R and X range:

- 0...10000, -10000...10000 Ohm in numerical modes
- 0...1000, -1000...1000 Ohm in chart modes

Display modes:

- SWR at single or multiple frequencies
- SWR, return loss, R, X, Z, L, C at single frequency
- SWR chart, 100 points
- R, X chart, 100 points
- Smith chart, 100 points
- Return loss chart, 100 points
- Cable tools (stub tuner, length & velocity factor, cable loss and characteristic impedance measurement)

Optional open-short-load calibration.

RF output:

- Connector type: UHF (SO-239)
- Output signal shape: square, 0.06 to 55 MHz
- Output power: +13 dBm (at 50 Ohm load)

Power:

- Two 1.5V alkaline batteries, type AA
- Two 1.2V Ni-MH batteries, type AA
- Max. 4 hours of continuous measurement, max. 2 days in stand-by mode when fully charged batteries are used
- When the analyzer is connected to a PC or a DC adapter with USB socket, it takes power from these sources

Interface:

- 320×240 color TFT display
- 6x3 keys on the water-proof keypad
- Multilingual menus and help screens
- USB connection to a personal computer

Dimensions: 103 × 207 × 37 mm
(4.1 × 8.1 × 1.4 in)

Operating temperature: 0...40 °C
(32...104 °F)

Weight: 310 g (10.9 oz) w/o batteries

Warranty: 2 years

Made in Ukraine.

Annex 2 Precautions



Never connect the analyzer to your antenna in thunderstorms. Lightning strikes as well as static discharge may kill the operator.



Never leave the analyzer connected to your antenna after you finished operating it. Occasional lightning strikes or nearby transmitters may permanently damage it.



Never inject RF signal or DC voltage into the antenna connector of the analyzer. Do not connect it to your antenna if you have active transmitters nearby.



Avoid static discharge while connecting a cable to the analyzer. It is recommended to ground the cable before connecting it.



Do not leave the analyzer in active measurement mode when you are not actually using it. This may cause interference to nearby receivers.



If using a personal computer, **first** connect the cable to the antenna connector of the analyzer, **then** plug the analyzer to the computer USB port. This will protect the analyzer from static discharges.

Annex 3

Tools menu

For the quick access to the the Tools menu, press the **F** + **8** key combination.

Stub tuner

The Stub tuner mode is designed to help making or checking $1/4\text{-}\lambda$ or $1/2\text{-}\lambda$ coaxial stubs.

Connect either open or short circuited cable to the analyzer and press (OK) to start.



The analyzer will immediately show resonant frequencies for both quarterwave and halfwave stubs.

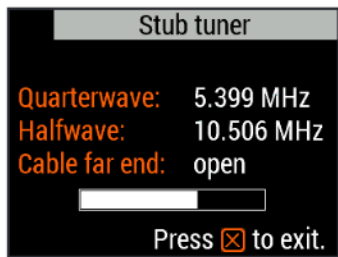
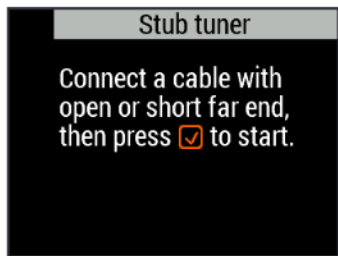

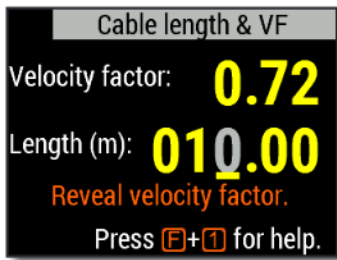
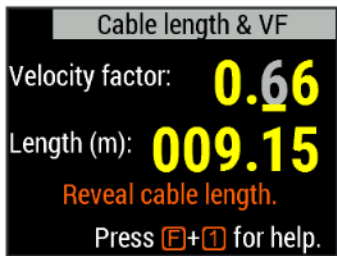
Longer cables have lower resonant frequency.





Length & VF

Knowing the *velocity factor*, a physical length of a cable can be easily calculated. Press the  (Up) button and edit the value of the velocity factor, then press  (OK) to start measurement.

To find the *velocity factor* of an unknown cable, press the  (Down) key and enter the physical length, then press  (OK).

*The velocity factor depends on a type of your transmission line.
For instance, RG-58 cable with polyethylene insulator has VF=0.66.*

Cable loss

To measure the *loss* in a coaxial cable, connect a piece of a cable to the antenna connector of the analyzer. Make sure the far end of the cable is **open circuited**. Press (OK) to start.

Next, **short circuit** the far end of the cable and press (OK) to continue.

Once the analyzer finishes the measurement, you will see the **Loss versus frequency chart**. Use (Left) and (Right) cursor keys to change frequency and watch the loss value in decibels at the bottom of the analyzer's screen.

To see the list of other keypad shortcuts, press the (Help) key.

Cable loss measurement

Step 1 of 2:

Connect an OPEN CIRCUIT cable to the antenna connector, then press the key to start.

Exit

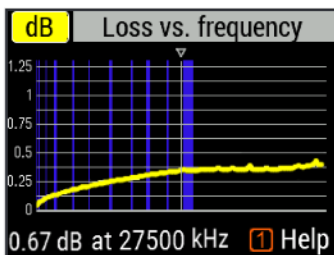

Cable impedance

Step 1 of 2:

Connect an OPEN CIRCUIT cable to the antenna connector, then press the key to start.

Exit

Cable impedance

To measure the *characteristic impedance*, use a piece of an open circuited cable: a half of a meter (or a foot) or longer should be fine. Press (OK) to start.

Next, the far end of the cable should be short circuited. Press (OK) to continue.

There are several reasons why the resulting chart does not look smooth, so we need to use (Left) and (Right) cursor keys to find the location where the impedance is stable. The result is shown at the bottom left corner of the screen.

Use + (Up) and + (Down) key combinations to change the scale, if needed.

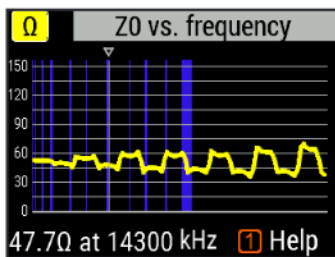

Self tests

There are several built-in self tests in the AA-55 ZOOM analyzer, which can be run by the user to make sure the analyzer is working properly.

Make sure *all cables or adapters* are disconnected from the antenna connector of your analyzer, then press (OK) to start the first test (**Detector test**).

You should see the “**Passed**” message in case of success.

Continue with two more tests: the second (**Built-in filter test**) and the third (**Test with load**). For the third test, make sure to connect a good 50 Ohm load *directly* to the analyzer’s antenna connector. See page 34 to know more about 50 Ohm loads.

Self tests

Step 1 of 3: Detector test.
Before starting the test, please unplug any cables or adapters from the analyzer, then press the key.

Exit

Self tests

Detector test **Passed**

Press the key to perform the next test.

Exit

Self tests

Step 3 of 3: Test with load.
Now connect a 50 Ohm load directly to the analyzer, then press the key.

Exit

Annex 4 Setup menu

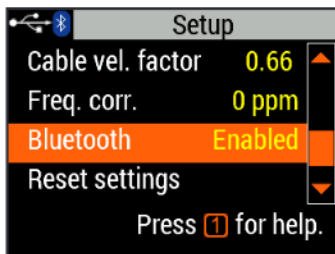
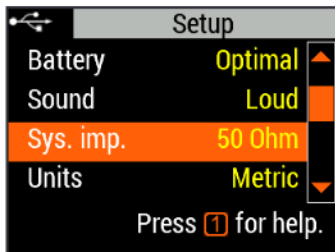
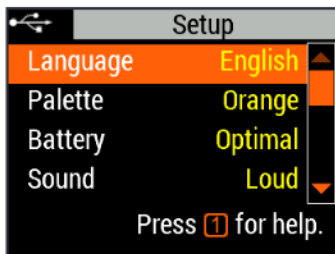

For the quick access to the **Setup** menu, press the **F** + **1** key combination.

- **Language** – select a language for the analyzer's menus
- **Palette** – choose a color scheme
- **Battery** – select a power consumption scheme
- **Sound** – select sound volume
- **Sys. imp.** – select system impedance (25, 50, 75, 100, 150, 200, 300, 450 or 600 Ohm) which affects SWR and return loss readings.
- **Units** – select metric (meters) or imperial (feet) units
- **Bands** – select an ITU region for highlighting of radio amateur bands
- **Cable vel. factor** – choose a velocity factor of the coaxial cable for the TDR mode
- **Freq. corr.** – frequency correction of the analyzer's oscillator
- **Reset settings** – reset the analyzer to factory defaults
- **Clear saved charts** – clear all memory slots

Annex 5 Calibration

RigExpert AA-55 ZOOM is a precise, self-calibrating instrument designed to operate “out of the box”. However, an industry-standard *open-short-load* calibration is supported by the analyzer.

The *standards* used for calibration should be of high quality (see page 34). This requirement is especially important for high frequencies. Three different calibration standards should be used: an “open”, a “short” and a “load” (50 Ohm OSL kit). A place where these standards are connected during calibration is called a *reference plane*. If the calibration is done at the far end of a transmission line, parameters of this line will be subtracted from measurement results and the analyzer will display “true” parameters of a load.

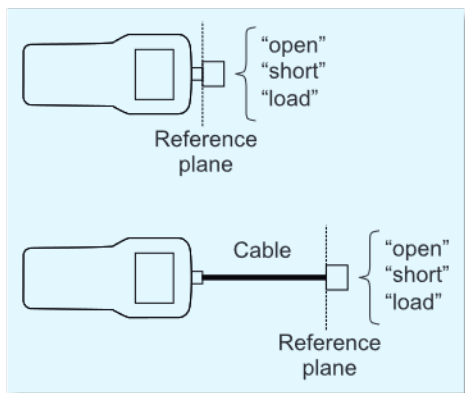

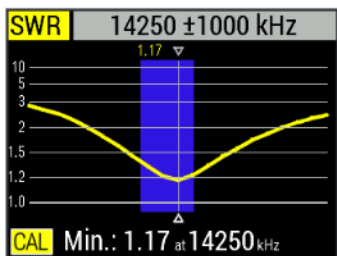
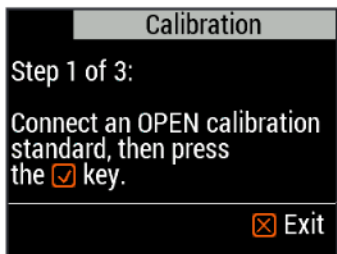
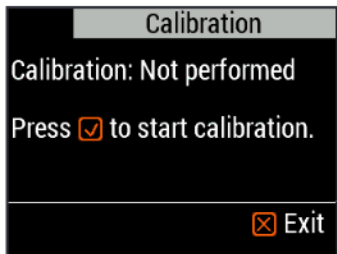

To perform an open-short-load calibration, select **Calibrate** in the **Main menu** (or just press the **F** + **2** key combination).

Following the instructions on the screen, connect “open”, “short” and “load” calibration standards to the antenna connector of the analyzer.

You may connect calibration standards to the far end of a cable, so the cable will be “nulled”.

To apply calibration, press the **F** + **2** key combination in any measurement mode. The “CAL” mark will appear at the bottom left corner of the screen.

Annex 6 Dummy loads

50 Ohm dummy loads are not all equal.

For *calibration* (see page 32), please use low-power RF terminators which provide low SWR over the wide frequency range.

High-power terminators, especially connected via long cables, are suitable neither for *calibration* purposes (page 32), nor for analyzer *self-tests* (page 30).



Amphenol
202109-10
1 Watt
terminator plug
Low SWR

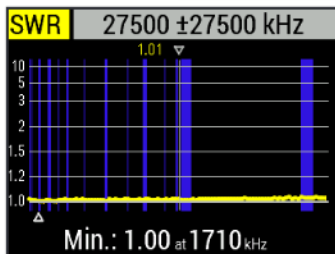

Bird 8201
500 Watt oil-cooled termination
High SWR

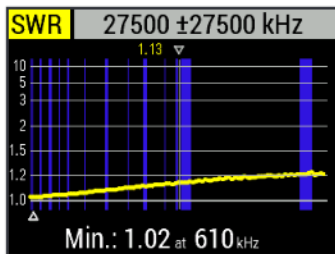

EC DECLARATION OF CONFORMITY
In accordance with EN ISO 17050-1: 2004

We, **Rig Expert Ukraine Ltd.** of **2 Solomenska Ploscha, Kyiv, 03035, Ukraine**

Declare under our sole responsibility that the product:

| | |
|--------------|-----------------------------------|
| Equipment | Antenna and cable analyser |
| Brand name | RigExpert |
| Model number | AA-55 ZOOM |

to which this declaration relates, is in conformity with the following standards and / or other normative documents:

| <i>Reference No.:</i> | <i>Title:</i> | <i>Edition / Date:</i> |
|-----------------------|---|------------------------|
| IEC61000-4-2 | Testing and measurement techniques - Electrostatic discharge immunity test | 2008 |
| IEC 61000-4-3 | Testing and measurement techniques - Radiated, radio-frequency, electromagnetic field immunity test | 2010 |

We hereby declare that the above named product is in conformity to all the applicable essential requirements of directive 2004/108/EC (*the EMC Directive*).

The technical documentation relevant to the above equipment will be held at:

TESTSVYAZ LLP

Suite 1, 5 Percy Street, Fitzrovia, London, W1T 1DG, The United Kingdom

/Denys Nechytailov/
Director

August 21, 2018

For private households: Information on Disposal for Users of WEEE

This symbol on the product(s) and / or accompanying documents means that used electrical and electronic equipment (WEEE) should not be mixed with general household waste. For proper treatment, recovery and recycling, please take this product(s) to designated collection points where it will be accepted free of charge.



Alternatively, in some countries, you may be able to return your products to your local retailer upon purchase of an equivalent new product. Disposing of this product correctly will help save valuable resources and prevent any potential negative effects on human health and the environment, which could otherwise arise from inappropriate waste handling.

Please contact your local authority for further details of your nearest designated collection point. Penalties may be applicable for incorrect disposal of this waste, in accordance with your national legislation.

For professional users in the European Union

If you wish to discard electrical and electronic equipment (EEE), please contact your dealer or supplier for further information.

For disposal in countries outside of the European Union

This symbol is only valid in the European Union (EU). If you wish to discard this product, please contact your local authorities or dealer and ask for the correct method of disposal.

<http://www.rigexpert.com>

Copyright © 2016-2020 Rig Expert Ukraine Ltd.

“RigExpert” is a registered trademark of Rig Expert Ukraine Ltd.



Doc. date: 17-May-2023