

Part Number : FK-FA1414

Product Name : MULTI-FUNCTION TWO CHANNEL RELAY SHIELD

This is the experimental board for Relay Controller as the fundamental controlling programming. It can be used to connect with sensors such as Temperature Controller, Moisture Indicator, Infrared Receiver Module, Ultrasonic Module. This circuit is adaptable and is able to upgrade to the other form of circuit such as Electronic Timer.

Specification

1. Power Supply direct from Microcontroller Board. (On the Relay circuit, it can be connected with internal power supply at 12VDC [from Arduino Board] or with external power supply.)
2. The circuit can be used with Microcontroller Board such as Arduino UNO R3.
3. The circuit board is composed of 3 sets which are 2 pieces of Relay circuit, 3 pieces of Switch and Sensor Connector such as Temperature Controller, Moisture Indicator, Infrared Receiver Module.
4. PCB dimension : 2.92"x2.08"

Circuit Function

The circuit is composed of 3 main sections:

Section1 Relay circuit which is connected with the port P6 and P9, composed of 1) Opto transistor: function as a driver for Relay circuit and 2) 12VDC Relay circuit which is supplied by two options: A. in case of supplying from Arduino Board (connect adaptor with the direct current at 12VDC to Arduino Board), put jumpers in J+ point and JG. B. In case of supplying the direct current at 12VDC from external power supply through connecting FK1414, remove jumpers from J+ point and JG point and supply the direct current at 12VDC from the external power supply to 12V point.

Section2 There are 3 switches in Switch circuit connected with the port P10,P11 and P12.

Section3 is for connecting with Sensor Connectors;

-CON1 is used to connect with Moisture Indicator DHT11, DHT22 or Ultrasonic Module HC-SR04 through the port A1 and A2. To connect CON1 with Moisture Indicator, jump the jumper JA1 and JA2 but if we want to connect with Ultrasonic Module, remove the jumpers of JA1 and JA2.

-CON2 is used to connect with Moisture Indicator such as 18B20 through the port P7.

-CON3 is used to connect with Infrared Receiver Module through the port P8.

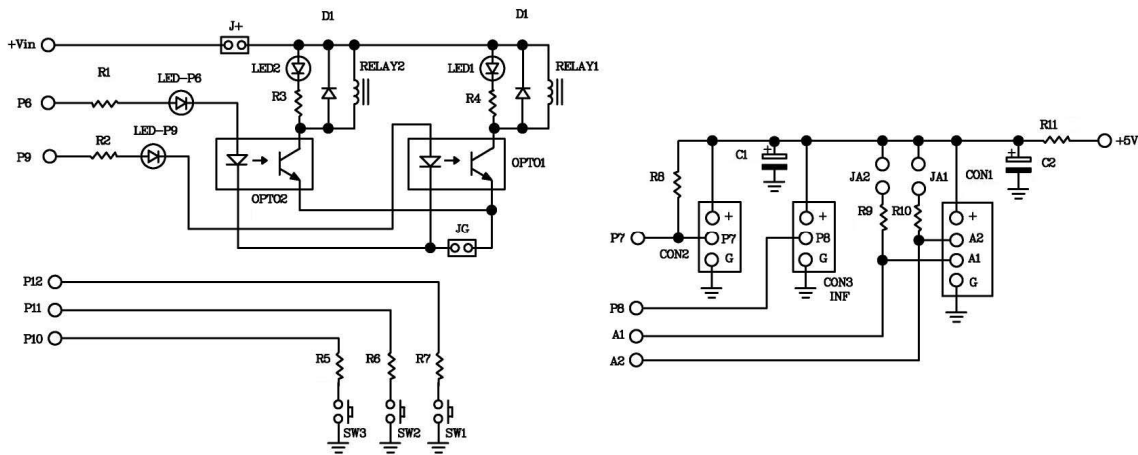

Figure 1. Circuit Diagram of FK1414

Circuit Assembling

According to Figure 2, the easy assembling should be started with putting the smallest part on the circuit which is resistor. Caution, all parts must be on the right electrodes such as LED. Please see Figure 3 for putting parts on electrodes. On the soldering, use a soldering iron max. 40 watts and tin/lead at 60/40 with flux. After assembling and soldering, re-check the positions of each part. In case some parts are on the wrong positions, use solder suction or solder wick to correct the positioning of those parts.

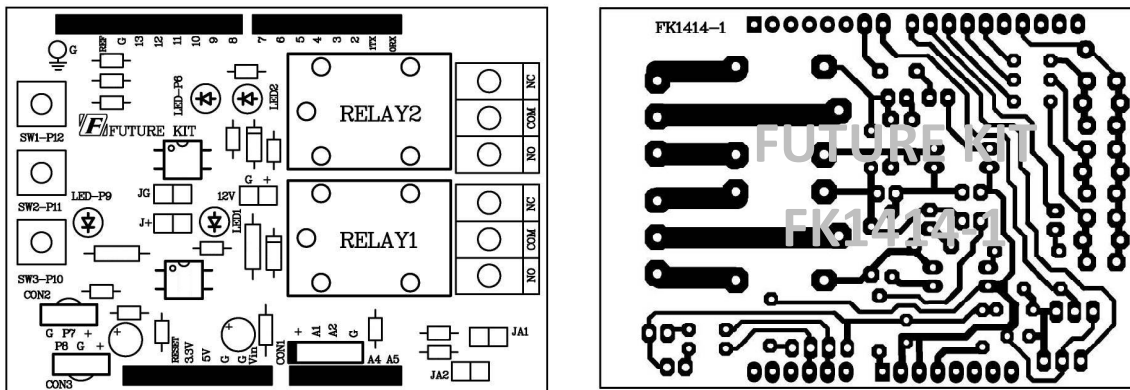

Figure 2. The positions for assembling and PCB copper line.

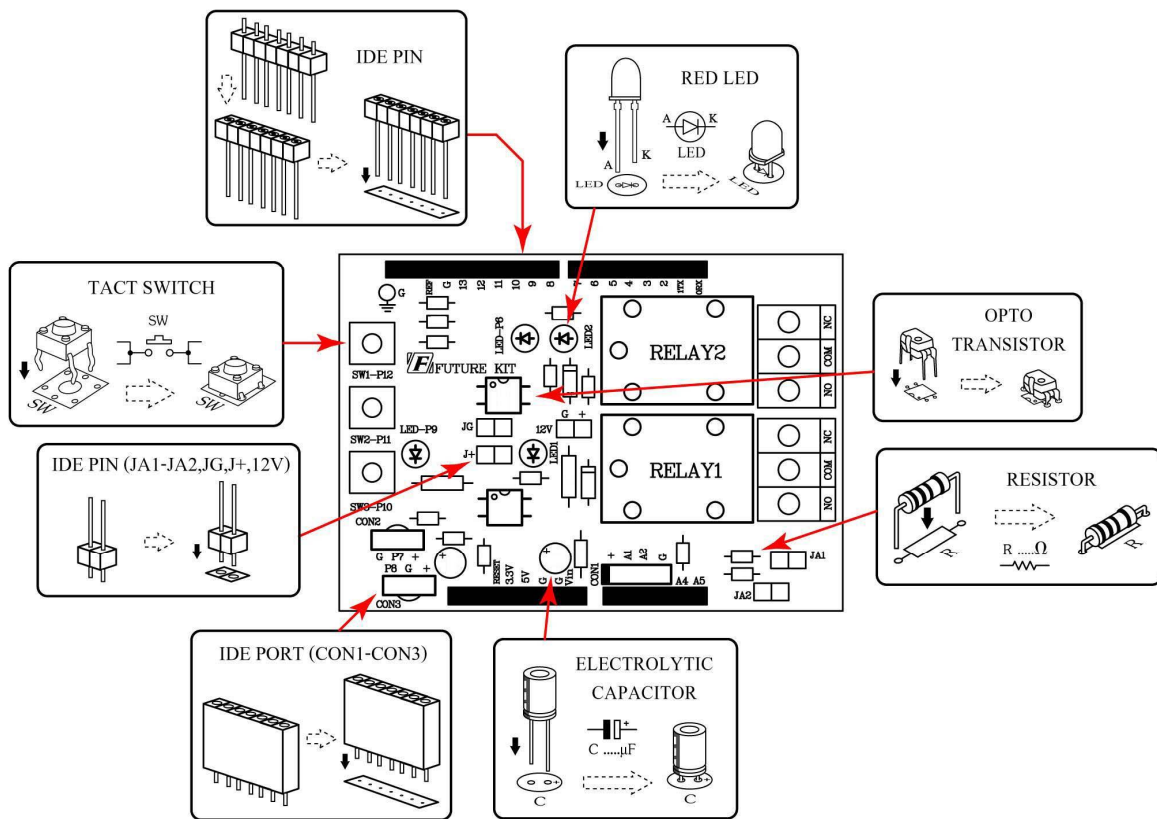

Figure 3. Positioning the parts on PCB

Programming instrument for the experimental board

1.FK-FA1414 MULTI-FUNCTION TWO CHANNEL RELAY SHIELD	1	set
2. 12VDC 500mA. Power Adaptor	1	Piece
3. Microcontroller Board ex. Arduino UNO R3	1	set
4. USB Cable	1	Piece
5. Computer Set	1	Set
6. Arduino Software	1	Piece

Testing Arduino UNO R3 Board

- 1.Connect USB cable with USB port of computer and USB port of Arduino UNO R3 Board.



Figure 4. Connecting USB cable with USB port of Arduino Board

2. Open Arduino program by double-click on Arduino icon. Go to the menu bar, click on File and choose Open. Afterwards, go to "EX" folder and open "TEST" folder. Then click on "Test" file.



Figure 5. Opening Arduino program

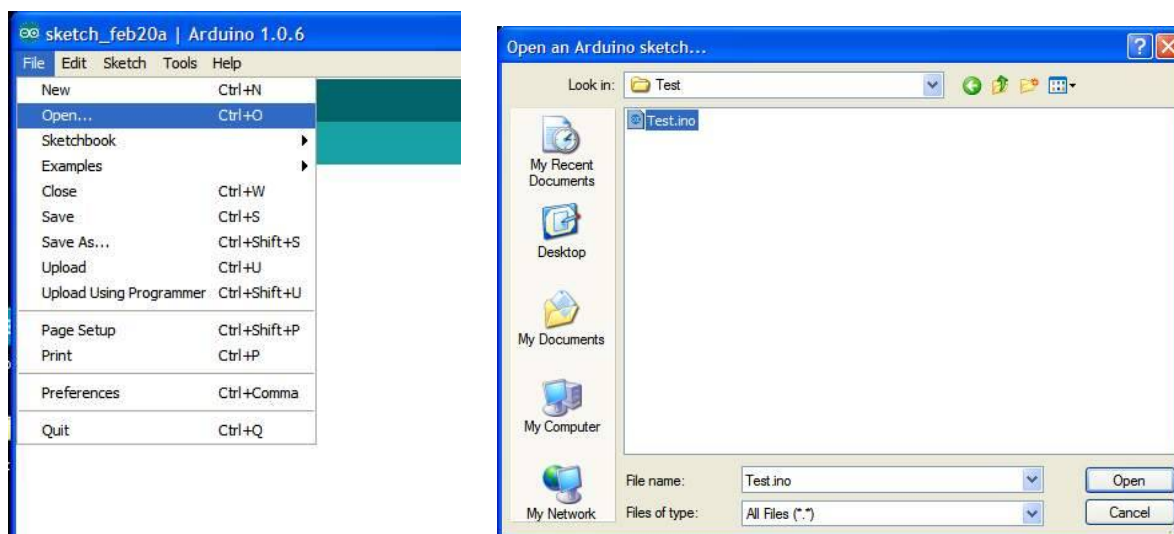

Figure 6. TEST Program

3. Download TEST program to Arduino Board.



Figure 7. Downloading TEST program

4. After downloading, the LED L on Arduino Board will blink which means Arduino board is working.



Figure 8. The position of LED L on Arduino Board circuit

The details of TEST program, Flashing Light Program, Arduino UNO R3 experiment.

```
void setup() {  
  pinMode(13, OUTPUT);    // Set the pin 13 is OUTPUT pin.  
}  
  
void loop() {  
  digitalWrite(13, HIGH); // LED at the pin 13 is light-on.  
  delay(1000);           // delay time 1 second  
  digitalWrite(13, LOW); // LED at the pin 13 is light-off.  
  delay(1000);           // delay time 1 second  
}
```

The method to connect the circuit with Arduino UNO R3 board

Connect FK1410 board with Arduino UNO R3 board by following Figure 9.

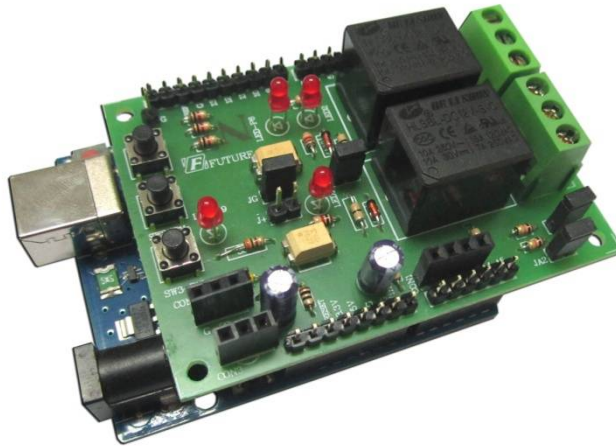

Figure 9. Connecting FK1413 board with Arduino UNO R3 board

Programming

1. Connect Arduino UNO R3 board with experimental board by following the instruction of the method to connect the circuit with Arduino UNO R3 board. Then jump the jumper at J+ point and JG point.

2. Connect the USB cable with USB port of computer and USB port of Arduino UNO R3 board.



Figure 10. Wiring the USB cable

3. Double-click on Arduino icon to open Arduino program. Go to "File" in menu bar and choose "Open". Click on "Ex" folder, choose "FK1414" folder, choose "LAB1414-1" folder and click on "LAB1414-1" file.

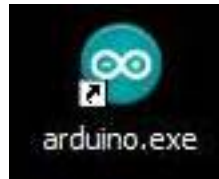

Figure 11. Opening Arduino Program

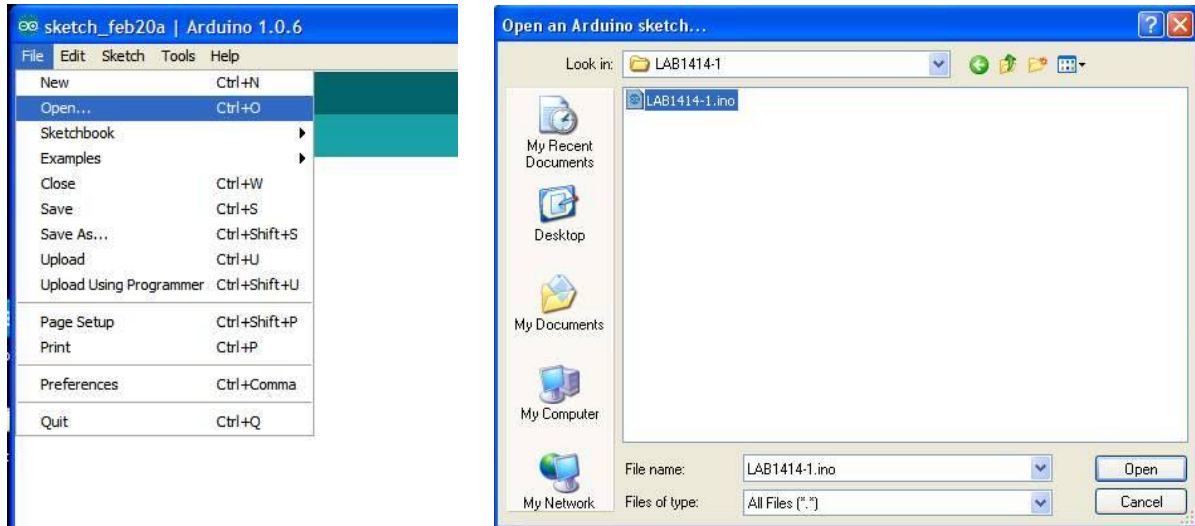

Figure 12. LAB1414-1 program

4.Download LAB1414-1 program to Arduino board.



Figure 13. Downloading LAB1414-1 program

5.After completing downloading, the LED at FK1414 board will be light-on, relay-on and light-off, relay-off alternately which means the relay circuit section is working.

6.Connect LED TEST with CON3 point. The pin of Resistor must be connected with G point and the pin of LED TEST must be connected with P8. Open LAB1414-2 program in "FK1414" folder. Afterwards, download LAB1414-2 program to Arduino board, LED TEST will blink. Remove LED TEST

and connect it with CON2 point, do it in the same way as connecting with CON3 point but change the pin's position from P8 to P7. LED TEST will blink. Again remove LED TEST and connect it with CON1 point and put the pin that's no connection with Resistor in A1, then A2. If LED blinks, it means the connector point is working.

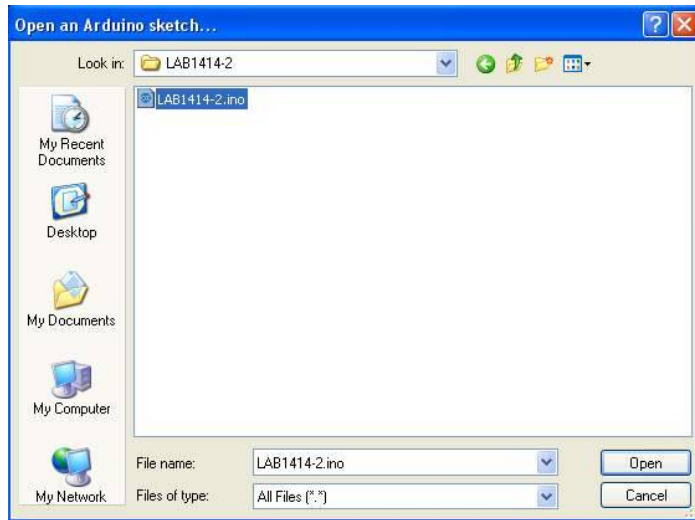

Figure 14. LAB1414-2 program



Figure 15. Downloading LAB1414-2 program

7. Open LAB1414-3 in "FK1414" folder and download this program to Arduino UNO R3 board.

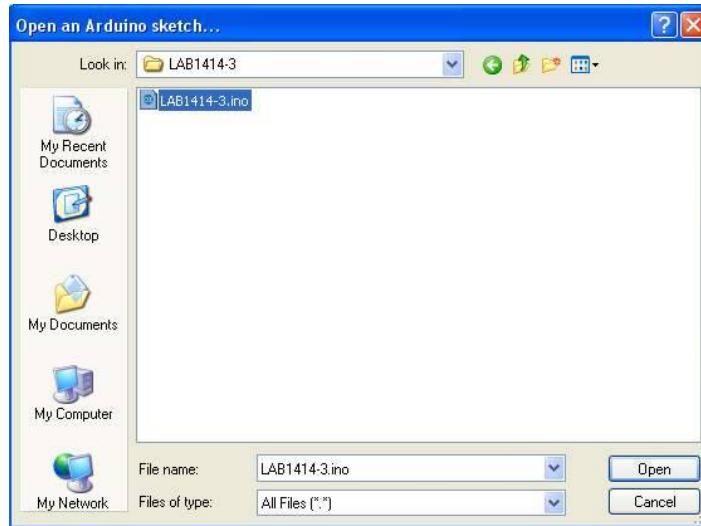

Figure 16. LAB1414-3 program

8. Press and hold switch SW1, LED2 and LED-P6 will be light-on, release switch SW1, LED2 and LED-P6 will be light-off.

9. Press and hold switch SW2, LED2 and LED-P6 will be light-on, release switch SW2, LED2 and LED-P6 will be light-off.

10. Press and hold switch SW3, LED2 and LED-P6 will be light-on, release switch SW3, LED2 and LED-P6 will be light-off.

11. If the test in step 8 to step 10 works, it means the switch circuit is functional.

The details of LAB1414-1 RELAY TEST program

```
void setup() {  
    pinMode(6, OUTPUT);        // Set the pin 6 is OUTPUT pin.  
    pinMode(9, OUTPUT);        // Set the pin 9 is OUTPUT pin.  
}  
  
void loop() {  
    digitalWrite(6, HIGH);      // RELAY at the pin 6 is working.  
    delay(1000);                // delay time 1 second  
  
    digitalWrite(6, LOW);       // RELAY at the pin 6 is stop working.  
    delay(1000);                // delay time 1 second  
  
    digitalWrite(9, HIGH);      // RELAY at the pin 9 is working.  
    delay(1000);                // delay time 1 second
```

```
digitalWrite(9, LOW);      // RELAY at the pin 9 is stop working.  
  
delay(1000);              // delay time 1 second  
  
}
```

Function of LAB1414-1 program

The program will determine pin 6 and pin 9 as OUTPUT pin. The relay at pin 6 and pin 9 will work at 1 second and will be extinguished at 1 second, the program will start repeating the relay.

Remark: In case we want LED to play ON/OFF frequently, we can reduce the value in the parentheses by commanding “delay”. The unit of the digit is millisecond.

The details of LAB1414-2 CON1-CON3 CONNECTOR TEST program

```
void setup() {  
  
  pinMode(7, OUTPUT);      // Set the pin 7 is OUTPUT pin.  
  pinMode(8, OUTPUT);      // Set the pin 8 is OUTPUT pin.  
  pinMode(A1, OUTPUT);     // Set the pin A1 is OUTPUT pin.  
  pinMode(A2, OUTPUT);     // Set the pin A2 is OUTPUT pin.  
  
}  
  
void loop() {  
  
  digitalWrite(7, HIGH);   // LED at the pin 7 is light-on.  
  digitalWrite(8, HIGH);   // LED at the pin 8 is light-on.  
  digitalWrite(A1, HIGH);  // LED at the pin A1 is light-on.  
  digitalWrite(A2, HIGH);  // LED at the pin A2 is light-on.  
  
  delay(1000);             // delay time 1 second  
  
  digitalWrite(7, LOW);    // LED at the pin 7 is light-off.  
  digitalWrite(8, LOW);    // LED at the pin 8 is light-off.  
  digitalWrite(A1, LOW);   // LED at the pin A1 is light-off.  
  digitalWrite(A2, LOW);   // LED at the pin A2 is light-off.  
  
  delay(1000);             // delay time 1 second  
  
}
```

Function of LAB1414-2 program

The program will determine pin 7, pin8, pin A1 and pin A2 as OUTPUT pin. It will light up the LED at pin 7, pin8, pin A1 and pin A2 at 1 second and will extinguish at 1 second, the program will start repeating the all LED.

Remark: In case we want LED ON/OFF frequently, we can reduce the value in the parentheses by commanding “delay”. The unit of the digit is millisecond.

The details of LAB1414-3 SWITCH TEST program

```
void setup() {  
  
    pinMode(6, OUTPUT);           // Set the pin 6 is OUTPUT pin.  
  
    pinMode(12, INPUT_PULLUP);   // Set the pin 12 is INPUT pin and using the PULL UP  
function.  
  
    pinMode(11, INPUT_PULLUP);   // Set the pin 11 is INPUT pin and using the PULL UP  
function.  
  
    pinMode(10, INPUT_PULLUP);   // Set the pin 10 is INPUT pin and using the PULL UP  
function.  
  
}  
  
void loop() {  
  
    int SW3 = digitalRead(10);    // Set “SW3” word is the variable of value at pin 10.  
  
    int SW2 = digitalRead(11);    // Set “SW2” word is the variable of value at pin 11.  
  
    int SW1 = digitalRead(12);    // Set “SW1” word is the variable of value at pin 12.  
  
    if (SW3 == LOW) { digitalWrite(6, HIGH); } else { digitalWrite(6, LOW); }  
  
    // If press the switch SW3 (LOW status), LED at pin 6 will be light-on. But if no press the  
switch SW3 (HIGH status), LED at pin 6 will be light-off.  
  
    if (SW2 == LOW) { digitalWrite(6, HIGH); } else { digitalWrite(6, LOW); }  
  
    // If press the switch SW2 (LOW status), LED at pin 6 will be light-on. But if no press the  
switch SW2 (HIGH status), LED at pin 6 will be light-off.  
  
    if (SW1 == LOW) { digitalWrite(6, HIGH); } else { digitalWrite(6, LOW); }  
  
    // If press the switch SW1 (LOW status), LED at pin 6 will be light-on. But if no press the  
switch SW1 (HIGH status), LED at pin 6 will be light-off.  
  
}
```

Function of LAB1414-3 program

The program will determine pin 6 as OUTPUT pin and pin 10 to pin 12 as INPUT pin. Besides INPUT pin, pin 10 to pin 12 can be used for activating the function PULL UP as well.

Press and hold switch SW3 at pin 10, LED will be light-on, release switch SW3, LED will be light-off.

Press and hold switch SW2 at pin 11, LED will be light-on, release switch SW2, LED will be light-off.

Press and hold switch SW1 at pin 12, LED will be light-on, release switch SW1, LED will be light-off.