

MOSFET – N-Channel, POWERTRENCH®

30 V, 7 A, 23 mΩ

FDS8984, FDS8984-F40

General Description

This N-Channel MOSFET has been designed specifically to improve the overall efficiency of dc-dc converters using either synchronous or conventional switching PWM controllers. It has been optimized for low gate charge, low $R_{DS(ON)}$ and fast switching speed.

Features

- Max $R_{DS(ON)} = 23\text{ m}\Omega$ @ $V_{GS} = 10\text{ V}$, $I_D = 7\text{ A}$
- Max $R_{DS(ON)} = 30\text{ m}\Omega$ @ $V_{GS} = 4.5\text{ V}$, $I_D = 6\text{ A}$
- Low Gate Charge
- 100% R_G Tested
- This Device is Pb-Free and Halogen Free

ABSOLUTE MAXIMUM RATINGS ($T_A = 25^\circ\text{C}$ unless otherwise noted)

Symbol	Parameter	Ratings	Unit
V_{DS}	Drain to Source Voltage	30	V
V_{GS}	Gate to Source Voltage	± 20	V
I_D	Drain Current	- Continuous (Note 1a)	7
		- Pulsed	30
E_{AS}	Single Pulse Avalanche Energy (Note 2)	32	mJ
P_D	Power Dissipation for Single Operation	1.6	W
	Derate Above 25°C	13	mW/ $^\circ\text{C}$
T_J, T_{STG}	Operating and Storage Temperature	-55 to +150	$^\circ\text{C}$

Stresses exceeding those listed in the Maximum Ratings table may damage the device. If any of these limits are exceeded, device functionality should not be assumed, damage may occur and reliability may be affected.

THERMAL CHARACTERISTICS

Symbol	Parameter	Ratings	Unit
$R_{\theta JA}$	Thermal Resistance, Junction-to-Ambient (Note 1a)	78	$^\circ\text{C}/\text{W}$
$R_{\theta JC}$	Thermal Resistance, Junction-to-Case (Note 1)	40	$^\circ\text{C}/\text{W}$

V_{DSS}	$R_{DS(ON)}\text{ MAX}$	$I_D\text{ MAX}$
30 V	23 mΩ @ $V_{GS} = 10\text{ V}$	7.0 A
	30 mΩ @ $V_{GS} = 4.5\text{ V}$	6.0 A

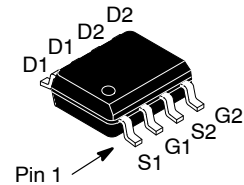

SOIC8
CASE 751EB

MARKING DIAGRAM

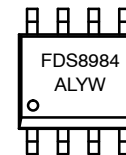

FDS8984 = Specific Device Code
A = Assembly Site
L = Wafer Lot Number
YW = Assembly Start Week

PIN ASSIGNMENT

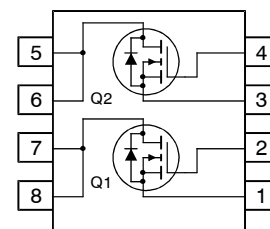

N-Channel MOSFET

ORDERING INFORMATION

Device	Package	Shipping†
FDS8984	SOIC8 (Pb-Free)	2500 / Tape & Reel
FDS8984-F40	SOIC8 (Pb-Free)	2500 / Tape & Reel

†For information on tape and reel specifications, including part orientation and tape sizes, please refer to our Tape and Reel Packaging Specification Brochure, [BRD8011/D](#).

FDS8984, FDS8984-F40

ELECTRICAL CHARACTERISTICS (T_A = 25°C unless otherwise noted)

Symbol	Parameter	Test Conditions	Min	Typ	Max	Unit
OFF CHARACTERISTICS						
BV _{DSS}	Drain to Source Breakdown Voltage	I _D = 250 μA, V _{GS} = 0 V	30	–	–	V
$\frac{\Delta BV_{DSS}}{\Delta T_J}$	Breakdown Voltage Temperature Coefficient	I _D = 250 μA, Referenced to 25°C	–	23	–	mV/°C
I _{DSS}	Zero Gate Voltage Drain Current	V _{DS} = 24 V, V _{GS} = 0 V V _{DS} = 24 V, V _{GS} = 0 V, T _J = 125°C	–	–	1 250	μA
I _{GSS}	Gate to Source Leakage Current	V _{GS} = ±20 V, V _{DS} = 0 V	–	–	±100	nA

ON CHARACTERISTICS (Note 3)

V _{GS(th)}	Gate to Source Threshold Voltage	V _{DS} = V _{GS} , I _D = 250 μA	1.2	1.7	2.5	V
$\frac{\Delta V_{GS(th)}}{\Delta T_J}$	Gate to Source Threshold Voltage Temperature Coefficient	I _D = 250 μA, Referenced to 25°C	–	–4.3	–	mV/°C
R _{DS(on)}	Drain to Source On-Resistance	V _{GS} = 10 V, I _D = 7 A V _{GS} = 4.5 V, I _D = 6 A V _{GS} = 10 V, I _D = 7 A, T _J = 125°C	–	19 24 26	23 30 32	mΩ

DYNAMIC CHARACTERISTICS

C _{iss}	Input Capacitance	V _{DS} = 15 V, V _{GS} = 0 V, f = 1.0 MHz	–	475	635	pF
C _{oss}	Output Capacitance		–	100	135	pF
C _{rss}	Reverse Transfer Capacitance		–	65	100	pF
R _G	Gate Resistance	f = 1.0 MHz	–	0.9	1.6	Ω

SWITCHING CHARACTERISTICS (Note 3)

t _{d(on)}	Turn-On Delay Time	V _{DD} = 15 V, I _D = 7 A, V _{GS} = 10 V, R _{GS} = 33 Ω	–	5	10	ns
t _r	Rise Time		–	9	18	ns
t _{d(off)}	Turn-Off Delay Time		–	42	68	ns
t _f	Fall Time		–	21	34	ns
Q _g	Total Gate Charge	V _{DS} = 15 V, V _{GS} = 10 V, I _D = 7 A	–	9.2	13	nC
Q _g	Total Gate Charge	V _{DS} = 15 V, V _{GS} = 5 V, I _D = 7 A	–	5.0	7	nC
Q _{gs}	Gate to Source Gate Charge		–	1.5	–	nC
Q _{gd}	Gate to Drain “Miller” Charge		–	2.0	–	nC

DRAIN-SOURCE DIODE CHARACTERISTICS

V _{SD}	Source to Drain Diode Voltage	I _{SD} = 7 A	–	0.9	1.25	V
		I _{SD} = 2.1 A	–	0.8	1.0	V
t _{rr}	Diode Reverse Recovery Time	I _F = 7 A, d _i /d _t = 100 A/μs	–	–	33	ns
Q _{rr}	Diode Reverse Recovery Charge		–	–	20	nC

Product parametric performance is indicated in the Electrical Characteristics for the listed test conditions, unless otherwise noted. Product performance may not be indicated by the Electrical Characteristics if operated under different conditions.

NOTES:

- R_{θJA} is the sum of the junction-to-case and case-to-ambient thermal resistance where the case thermal reference is defined as the solder mounting surface of the drain pins. R_{θJC} is guaranteed by design while R_{θCA} is determined by the user's board design.

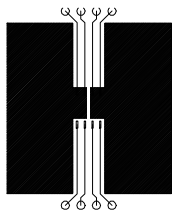

a. 78°C/W when mounted on a 0.5 in² pad of 2 oz copper

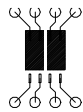

b. 125°C/W when mounted on a 0.02 in² pad of 2 oz copper

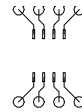

c. 135°C/W when mounted on a minimum pad.

Scale 1 : 1 on letter size paper

- Starting T_J = 25°C, L = 1 mH, I_{AS} = 8 A, V_{DD} = 27 V, V_{GS} = 10 V.
- Pulse Test: Pulse Width < 300 μs, Duty Cycle < 2.0%.

TYPICAL CHARACTERISTICS ($T_J = 25^\circ\text{C}$ unless otherwise noted)

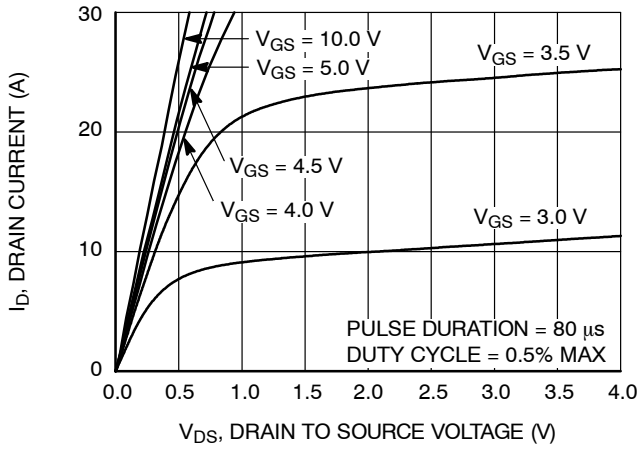

Figure 1. On Region Characteristics

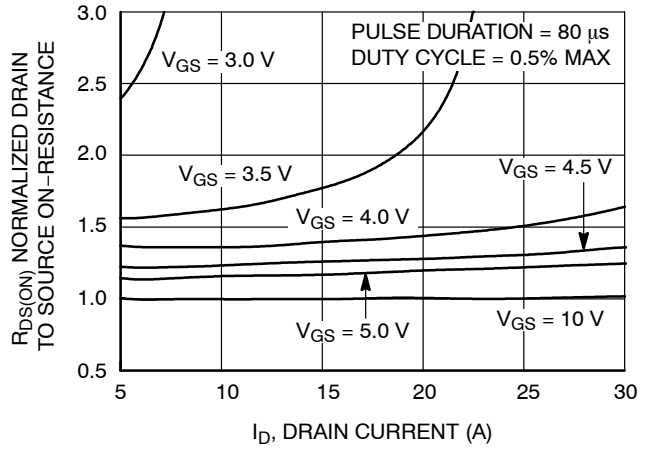

Figure 2. On-Resistance vs. Drain Current and Gate Voltage

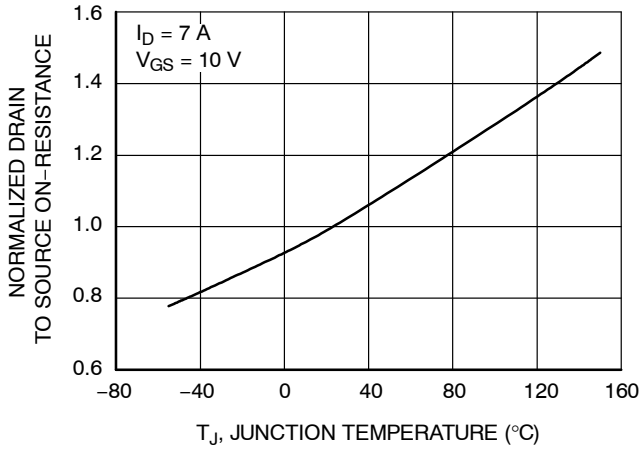

Figure 3. On-Resistance vs. Temperature

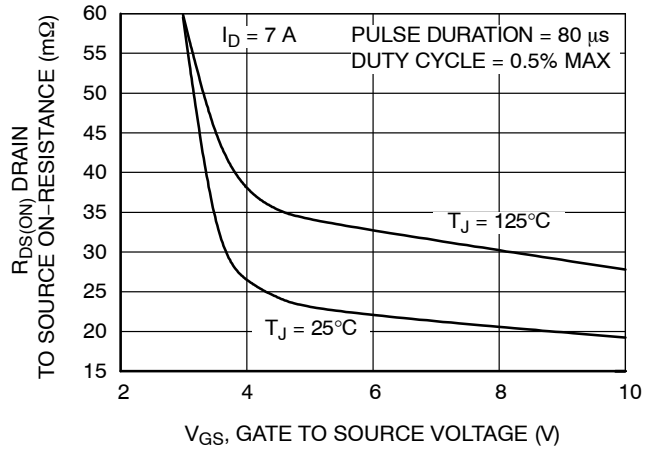

Figure 4. On-Resistance vs. Gate to Source Voltage

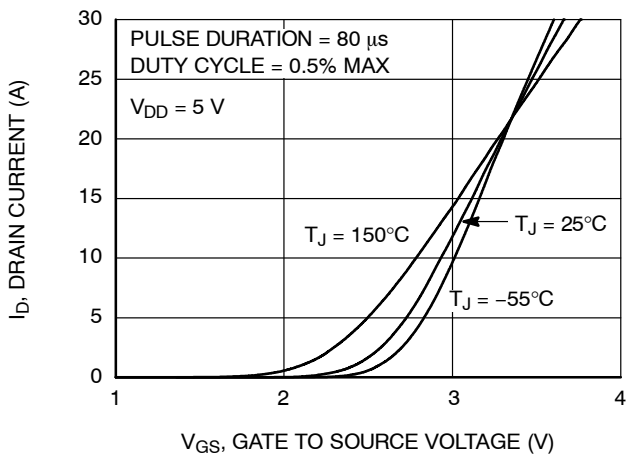

Figure 5. Transfer Characteristics

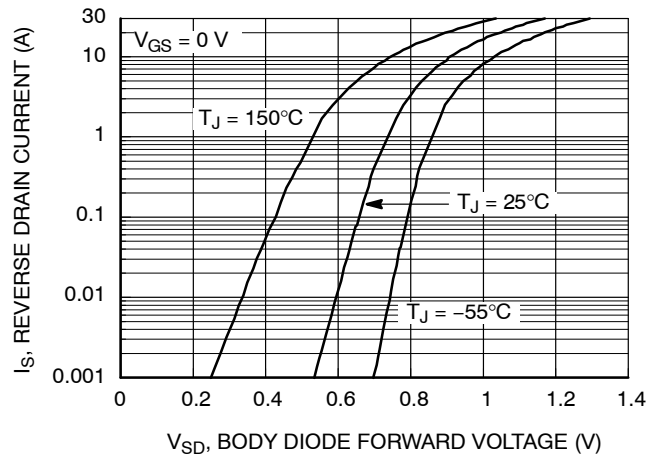

Figure 6. Source to Drain Forward Voltage vs. Source Current

TYPICAL CHARACTERISTICS ($T_J = 25^\circ\text{C}$ unless otherwise noted) (continued)

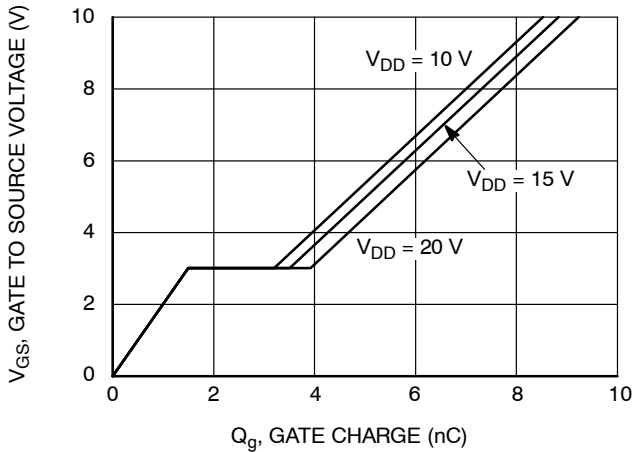

Figure 7. Gate Charge Characteristics

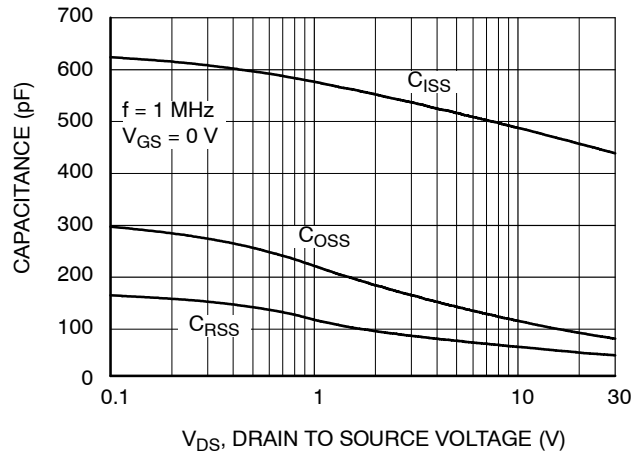

Figure 8. Capacitance vs. Drain to Source Voltage

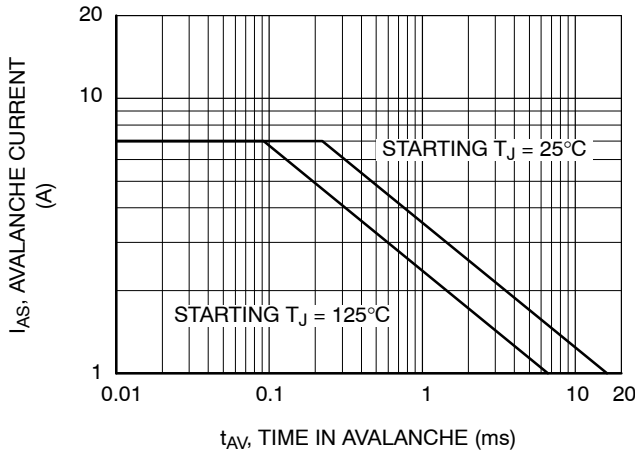

Figure 9. Unclamped Inductive Switching Capability

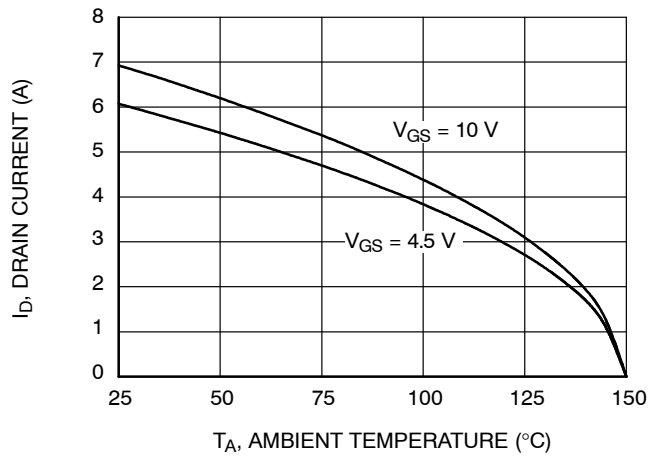

Figure 10. Maximum Continuous Drain Current vs. Ambient Temperature

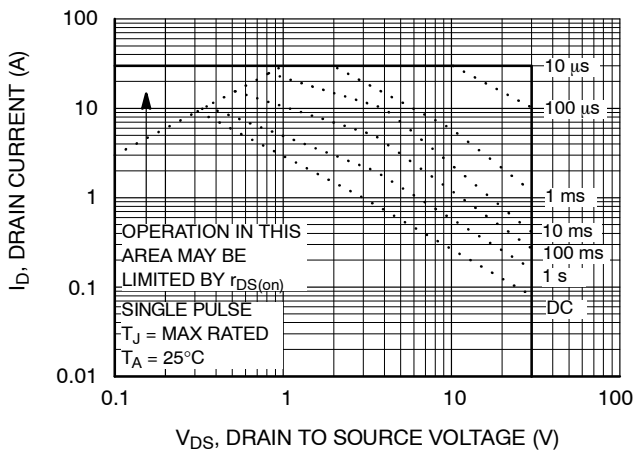

Figure 11. Forward Bias Safe Operating Area

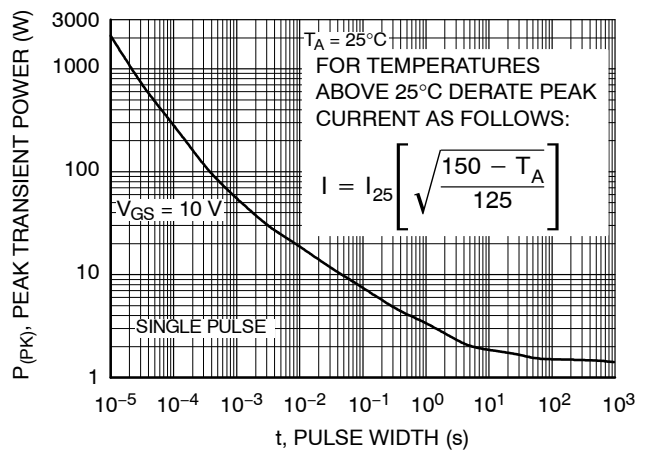

Figure 12. Single Pulse Maximum Power Dissipation

TYPICAL CHARACTERISTICS ($T_J = 25^\circ\text{C}$ unless otherwise noted) (continued)

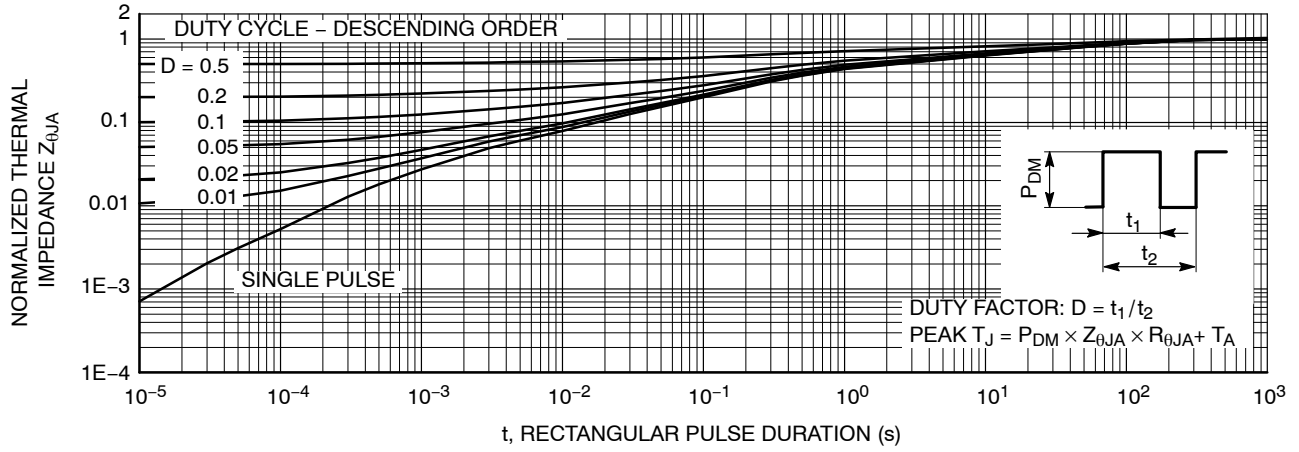

Figure 13. Transient Thermal Response Curve

MECHANICAL CASE OUTLINE
PACKAGE DIMENSIONS

ON Semiconductor®



SOIC8
CASE 751EB
ISSUE A

DATE 24 AUG 2017

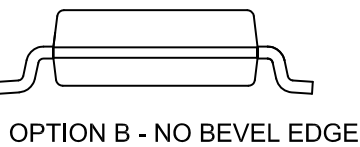
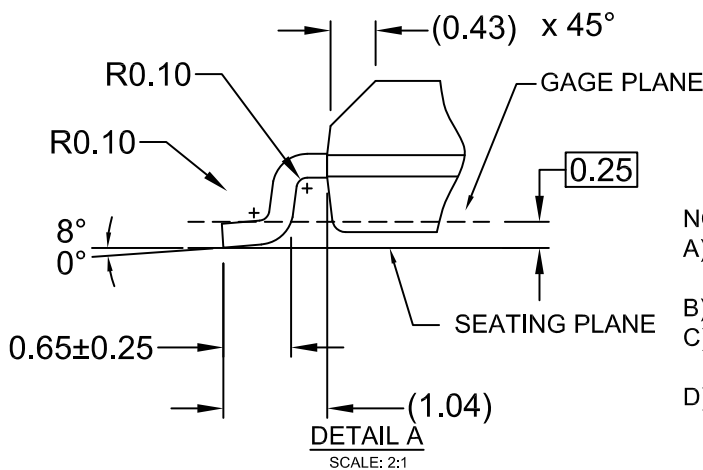
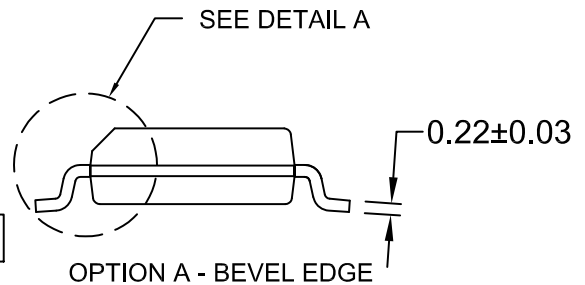
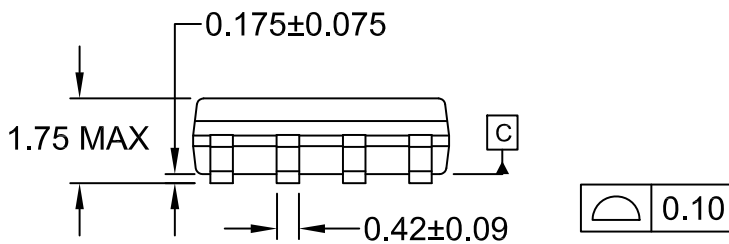
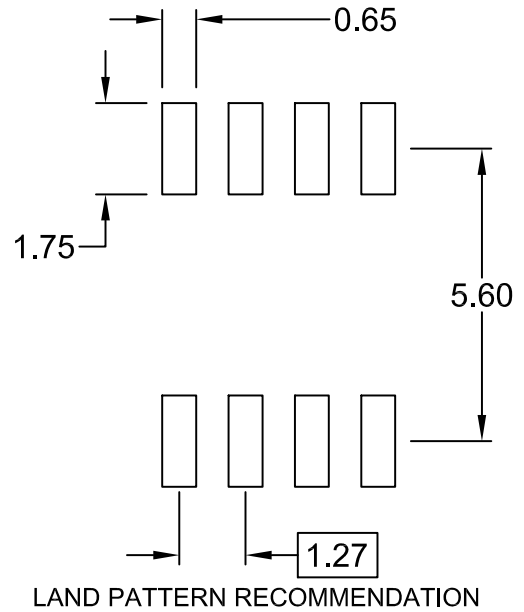
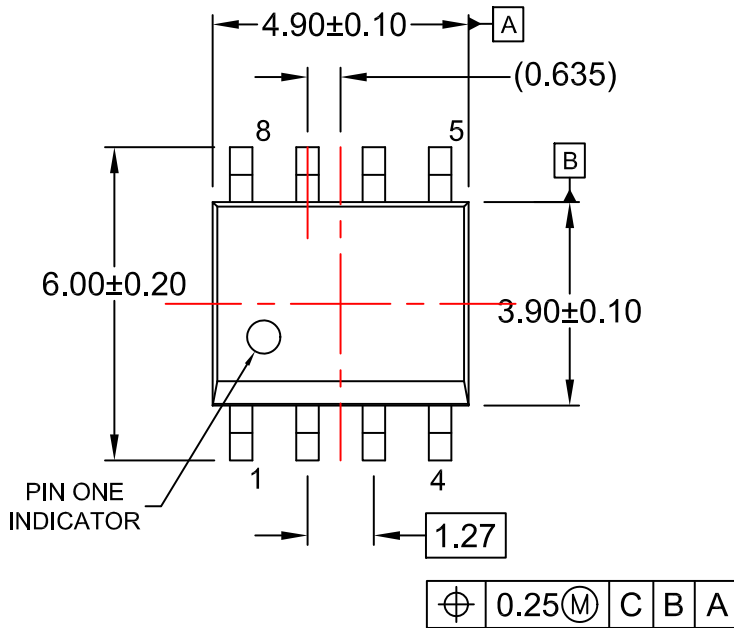

- NOTES:
 A) THIS PACKAGE CONFORMS TO JEDEC MS-012, VARIATION AA.
 B) ALL DIMENSIONS ARE IN MILLIMETERS.
 C) DIMENSIONS DO NOT INCLUDE MOLD FLASH OR BURRS.
 D) LANDPATTERN STANDARD: SOIC127P600X175-8M

DOCUMENT NUMBER:	98AON13735G	Electronic versions are uncontrolled except when accessed directly from the Document Repository. Printed versions are uncontrolled except when stamped "CONTROLLED COPY" in red.
DESCRIPTION:	SOIC8	PAGE 1 OF 1

ON Semiconductor and are trademarks of Semiconductor Components Industries, LLC dba ON Semiconductor or its subsidiaries in the United States and/or other countries. ON Semiconductor reserves the right to make changes without further notice to any products herein. ON Semiconductor makes no warranty, representation or guarantee regarding the suitability of its products for any particular purpose, nor does ON Semiconductor assume any liability arising out of the application or use of any product or circuit, and specifically disclaims any and all liability, including without limitation special, consequential or incidental damages. ON Semiconductor does not convey any license under its patent rights nor the rights of others.

onsemi, **Onsemi**, and other names, marks, and brands are registered and/or common law trademarks of Semiconductor Components Industries, LLC dba "**onsemi**" or its affiliates and/or subsidiaries in the United States and/or other countries. **onsemi** owns the rights to a number of patents, trademarks, copyrights, trade secrets, and other intellectual property. A listing of **onsemi**'s product/patent coverage may be accessed at www.onsemi.com/site/pdf/Patent-Marking.pdf. **onsemi** reserves the right to make changes at any time to any products or information herein, without notice. The information herein is provided "as-is" and **onsemi** makes no warranty, representation or guarantee regarding the accuracy of the information, product features, availability, functionality, or suitability of its products for any particular purpose, nor does **onsemi** assume any liability arising out of the application or use of any product or circuit, and specifically disclaims any and all liability, including without limitation special, consequential or incidental damages. Buyer is responsible for its products and applications using **onsemi** products, including compliance with all laws, regulations and safety requirements or standards, regardless of any support or applications information provided by **onsemi**. "Typical" parameters which may be provided in **onsemi** data sheets and/or specifications can and do vary in different applications and actual performance may vary over time. All operating parameters, including "Typicals" must be validated for each customer application by customer's technical experts. **onsemi** does not convey any license under any of its intellectual property rights nor the rights of others. **onsemi** products are not designed, intended, or authorized for use as a critical component in life support systems or any FDA Class 3 medical devices or medical devices with a same or similar classification in a foreign jurisdiction or any devices intended for implantation in the human body. Should Buyer purchase or use **onsemi** products for any such unintended or unauthorized application, Buyer shall indemnify and hold **onsemi** and its officers, employees, subsidiaries, affiliates, and distributors harmless against all claims, costs, damages, and expenses, and reasonable attorney fees arising out of, directly or indirectly, any claim of personal injury or death associated with such unintended or unauthorized use, even if such claim alleges that **onsemi** was negligent regarding the design or manufacture of the part. **onsemi** is an Equal Opportunity/Affirmative Action Employer. This literature is subject to all applicable copyright laws and is not for resale in any manner.

PUBLICATION ORDERING INFORMATION

LITERATURE FULFILLMENT:

Email Requests to: orderlit@onsemi.com

onsemi Website: www.onsemi.com

TECHNICAL SUPPORT

North American Technical Support:
Voice Mail: 1 800-282-9855 Toll Free USA/Canada
Phone: 011 421 33 790 2910

Europe, Middle East and Africa Technical Support:

Phone: 00421 33 790 2910

For additional information, please contact your local Sales Representative

Mouser Electronics

Authorized Distributor

Click to View Pricing, Inventory, Delivery & Lifecycle Information:

[onsemi:](#)

[FDS8984](#)