

Part Number: L-819EGW

High Efficiency Red  
Green

### Features

- Uniform light output.
- Low power consumption.
- 3 leads with one common lead.
- Long life - solid state reliability.
- RoHS compliant.

### Description

The High Efficiency Red source color devices are made with Gallium Arsenide Phosphide on Gallium Phosphide Orange Light Emitting Diode.

The Green source color devices are made with Gallium Phosphide Green Light Emitting Diode.

### Package Dimensions

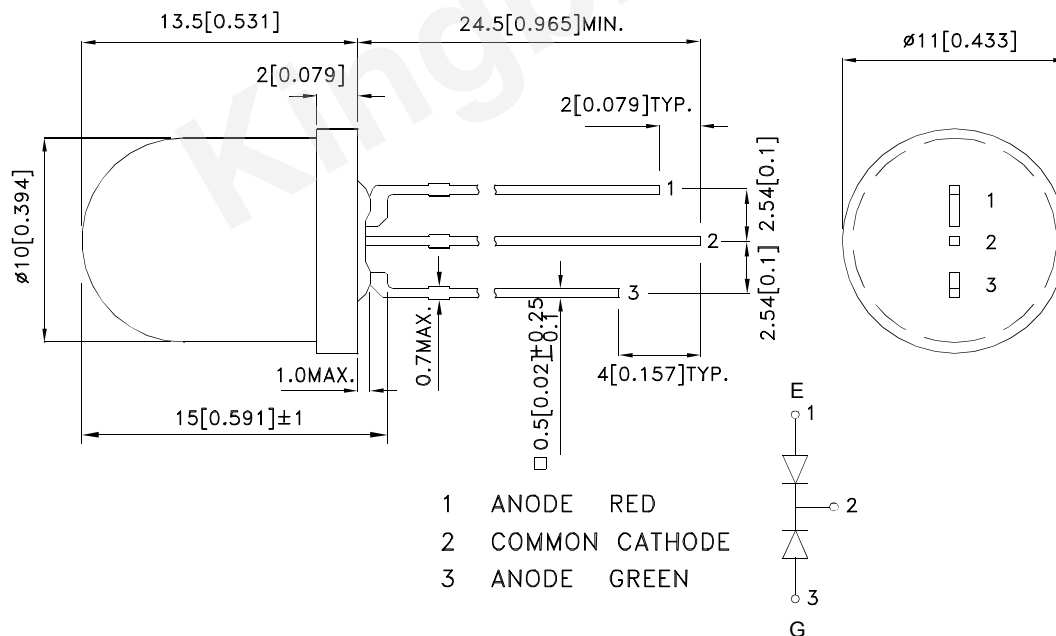

#### Notes:

1. All dimensions are in millimeters (inches).
2. Tolerance is  $\pm 0.25(0.01)$  unless otherwise noted.
3. Lead spacing is measured where the leads emerge from the package.
4. The specifications, characteristics and technical data described in the datasheet are subject to change without prior notice.



## Selection Guide

| Part No. | Dice                            | Lens Type      | Iv (mcd) [2]<br>@ 20mA |      | Viewing<br>Angle [1] |
|----------|---------------------------------|----------------|------------------------|------|----------------------|
|          |                                 |                | Min.                   | Typ. | 2θ1/2                |
| L-819EGW | High Efficiency Red (GaAsP/GaP) | White Diffused | 40                     | 80   | 50°                  |
|          |                                 |                | *30                    | *60  |                      |
|          | Green (GaP)                     |                | 15                     | 50   |                      |
|          |                                 |                | *15                    | *50  |                      |

Notes:

1. θ1/2 is the angle from optical centerline where the luminous intensity is 1/2 of the optical peak value.

2. Luminous intensity/ luminous Flux: +/-15%.

\* Luminous intensity value is traceable to the CIE127-2007 compliant national standards.

## Electrical / Optical Characteristics at TA=25°C

| Symbol | Parameter                | Device                       | Typ.       | Max.       | Units | Test Conditions |
|--------|--------------------------|------------------------------|------------|------------|-------|-----------------|
| λpeak  | Peak Wavelength          | High Efficiency Red<br>Green | 627<br>565 |            | nm    | IF=20mA         |
| λD [1] | Dominant Wavelength      | High Efficiency Red<br>Green | 617<br>568 |            | nm    | IF=20mA         |
| Δλ1/2  | Spectral Line Half-width | High Efficiency Red<br>Green | 45<br>30   |            | nm    | IF=20mA         |
| C      | Capacitance              | High Efficiency Red<br>Green | 15<br>15   |            | pF    | VF=0V;f=1MHz    |
| VF [2] | Forward Voltage          | High Efficiency Red<br>Green | 2<br>2.2   | 2.5<br>2.5 | V     | IF=20mA         |
| IR     | Reverse Current          | High Efficiency Red<br>Green |            | 10<br>10   | uA    | VR = 5V         |

Notes:

1.Wavelength: +/-1nm.

2. Forward Voltage: +/-0.1V.

3.Wavelength value is traceable to the CIE127-2007 compliant national standards.

## Absolute Maximum Ratings at TA=25°C

| Parameter                       | High Efficiency Red | Green | Units |
|---------------------------------|---------------------|-------|-------|
| Power dissipation               | 75                  | 62.5  | mW    |
| DC Forward Current              | 30                  | 25    | mA    |
| Peak Forward Current [1]        | 160                 | 140   | mA    |
| Reverse Voltage                 | 5                   |       | V     |
| Operating / Storage Temperature | -40°C To +85°C      |       |       |
| Lead Solder Temperature [2]     | 260°C For 3 Seconds |       |       |
| Lead Solder Temperature [3]     | 260°C For 5 Seconds |       |       |

Notes:

1. 1/10 Duty Cycle, 0.1ms Pulse Width.

2. 2mm below package base.

3. 5mm below package base.

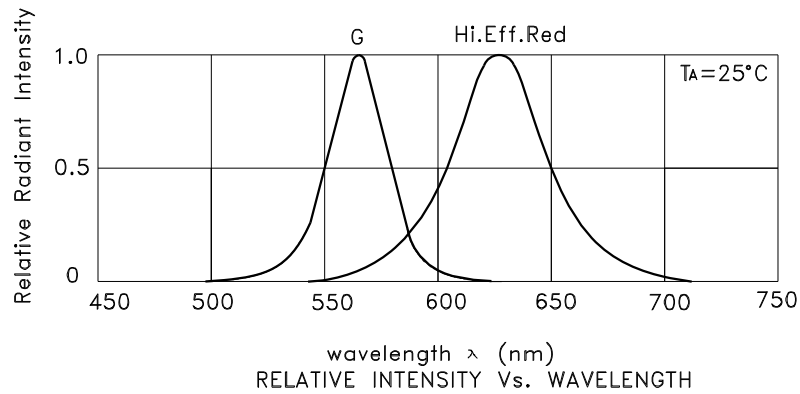

## L-819EGW High Efficiency Red

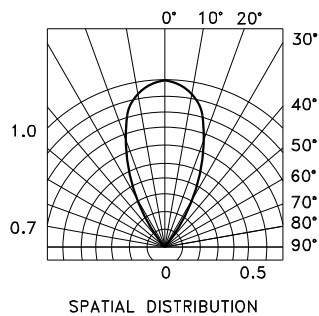
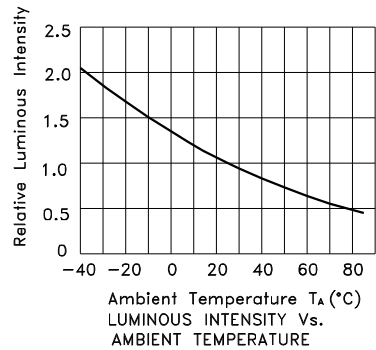
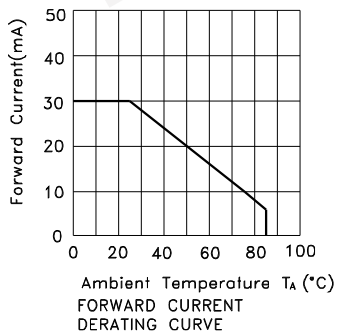
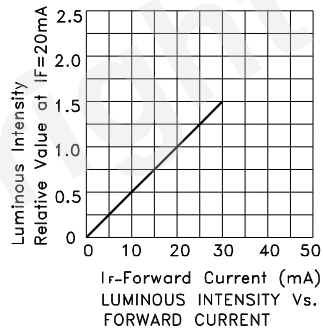
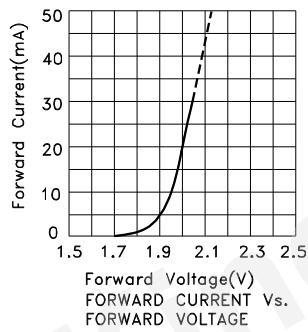

## Green

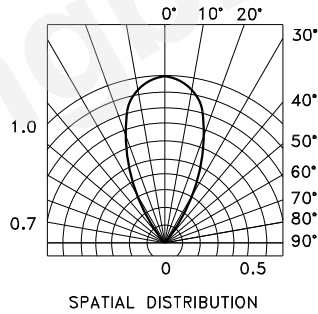
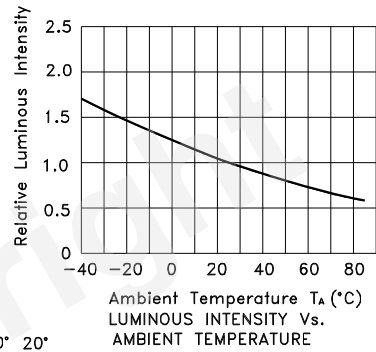
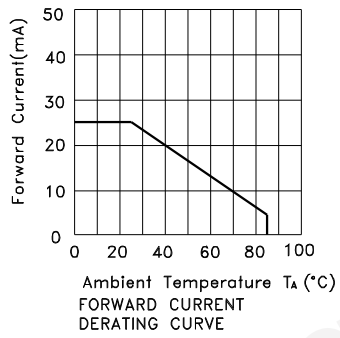
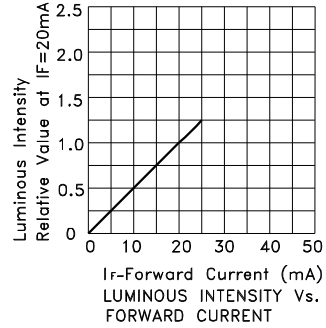
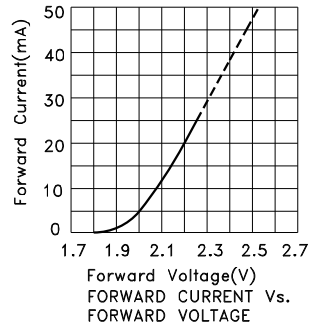

**PACKING & LABEL SPECIFICATIONS**

**L-819EGW**

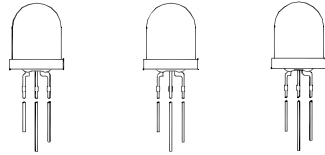

LABEL

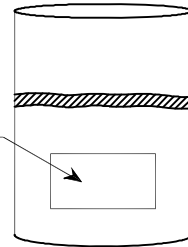

200PCS / BAG



OUTSIDE LABEL

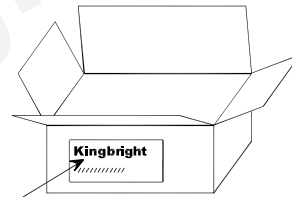

OUTSIDE LABEL

8K / 9# BOX

1K / 1# BOX

|  |   |     |            |        |
|--|---|-----|------------|--------|
| <h1>Kingbright</h1>  |   |     |            |        |
| P/NO: L-819xxx   |   |     |            |        |
| QTY: 200 pcs   | Q.C.  |     |            |        |
| S/N: XXXX  | <table border="1" style="margin: auto;"> <tr><td style="text-align: center;">Q C</td></tr> <tr><td style="text-align: center;">XX XX XXXX</td></tr> <tr><td style="text-align: center;">PASSED</td></tr> </table> | Q C | XX XX XXXX | PASSED |
| Q C  |   |     |            |        |
| XX XX XXXX   |   |     |            |        |
| PASSED   |   |     |            |        |
| CODE: XXX  |   |     |            |        |
| LOT NO:  |   |     |            |        |
| <br>XXXXXXXXXXXXXXXXXXXXXXXX |   |     |            |        |
| RoHS Compliant   |   |     |            |        |

## PRECAUTIONS

1. The lead pitch of the LED must match the pitch of the mounting holes on the PCB during component placement. Lead-forming may be required to insure the lead pitch matches the hole pitch. Refer to the figure below for proper lead forming procedures. (Fig. 1)

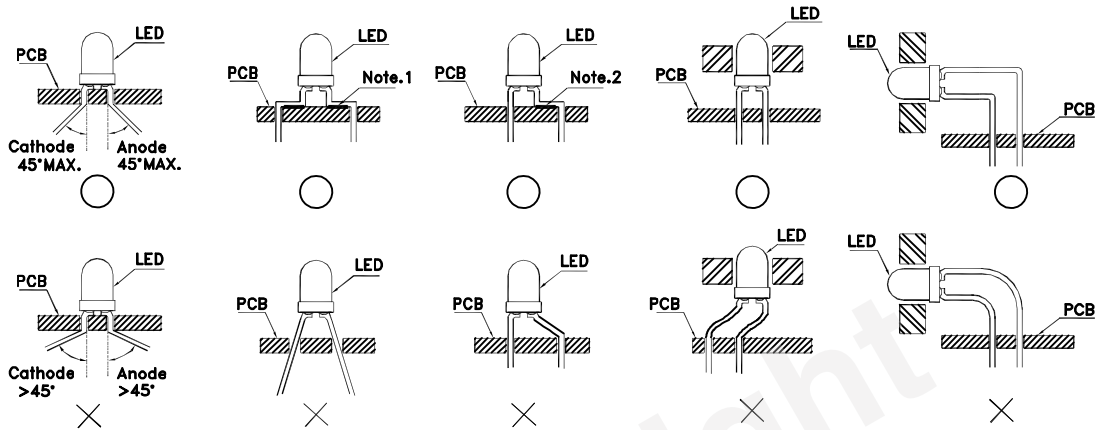

Fig.1

”O” Correct mounting method ”X” Incorrect mounting method

2. When soldering wire to the LED, use individual heat-shrink tubing to insulate the exposed leads to prevent accidental contact short-circuit. (Fig.2)
3. Use stand-offs (Fig.3) or spacers (Fig.4) to securely position the LED above the PCB.

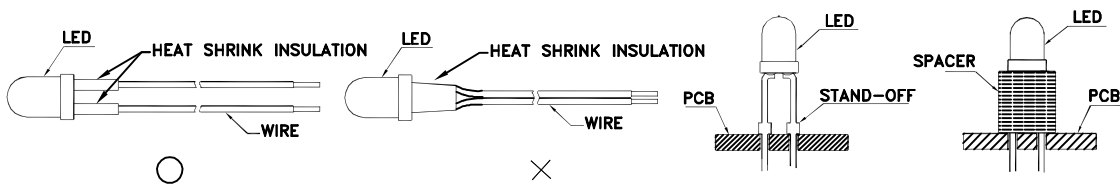

Fig. 2

Fig. 3

Fig. 4

4. Maintain a minimum of 2mm clearance between the base of the LED lens and the first lead bend. (Fig. 5 and 6)
5. During lead forming, use tools or jigs to hold the leads securely so that the bending force will not be transmitted to the LED lens and its internal structures. Do not perform lead forming once the component has been mounted onto the PCB. (Fig. 7)

6. Do not bend the leads more than twice. (Fig. 8)

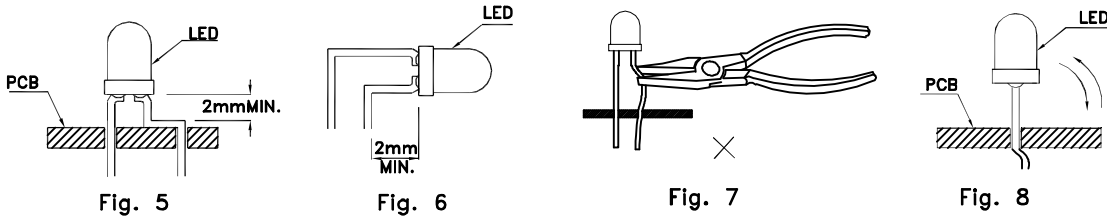

7. During soldering, component covers and holders should leave clearance to avoid placing damaging stress on the LED during soldering.

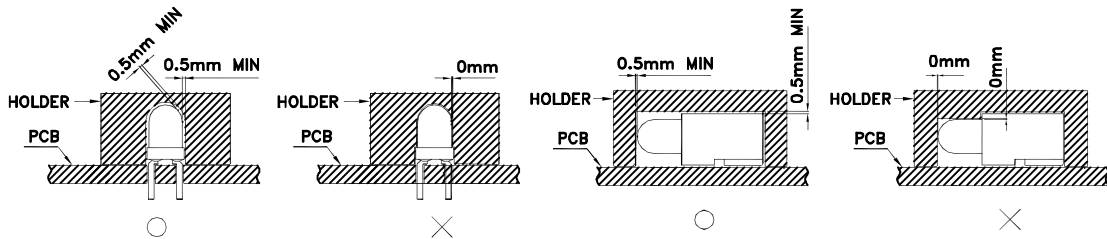

8. The tip of the soldering iron should never touch the lens epoxy.

9. Through-hole LEDs are incompatible with reflow soldering.

10. If the LED will undergo multiple soldering passes or face other processes where the part may be subjected to intense heat, please check with Kingbright for compatibility.

11. Recommended Wave Soldering Profiles:

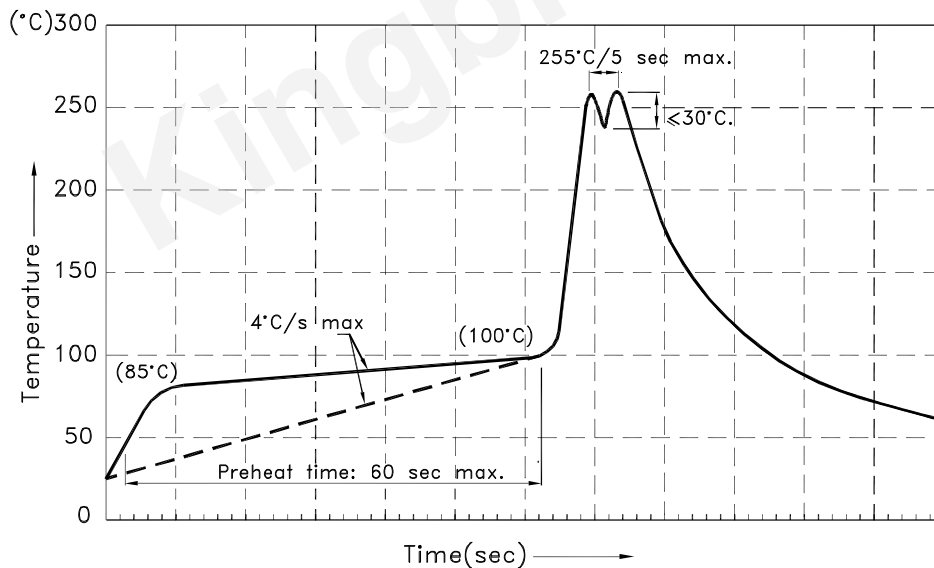

Notes:

1. Recommend pre-heat temperature of 105°C or less (as measured with a thermocouple attached to the LED pins) prior to immersion in the solder wave with a maximum solder bath temperature of 260°C
2. Peak wave soldering temperature between 245°C ~ 255°C for 3 sec (5 sec max).
3. Do not apply stress to the epoxy resin while the temperature is above 85°C.
4. Fixtures should not incur stress on the component when mounting and during soldering process.
5. SAC 305 solder alloy is recommended.
6. No more than one wave soldering pass.

Detailed application notes are listed on our website.

[http://www.kingbright.com/application\\_notes](http://www.kingbright.com/application_notes)