



EVERLIGHT ELECTRONICS CO.,LTD.

Device Number : CDLE-038-032 REV.: 3

5.0mm Round Type LED Lamps

PART NO. : 383-2USOC/S400-A4 ECN : _____ Page: 1/4

■ Features :

- Popular T-1 3/4 diameter package.
- Choice of various viewing angles.
- Available on tape and reel.
- Reliable and robust.

■ Descriptions :

- The series is specially designed for applications requiring higher brightness
- The led lamps are available with different colors, intensities, epoxy colors, etc.

■ Applications :

- TV set
- Monitor
- Telephone
- Computer

■ Package Dimensions:

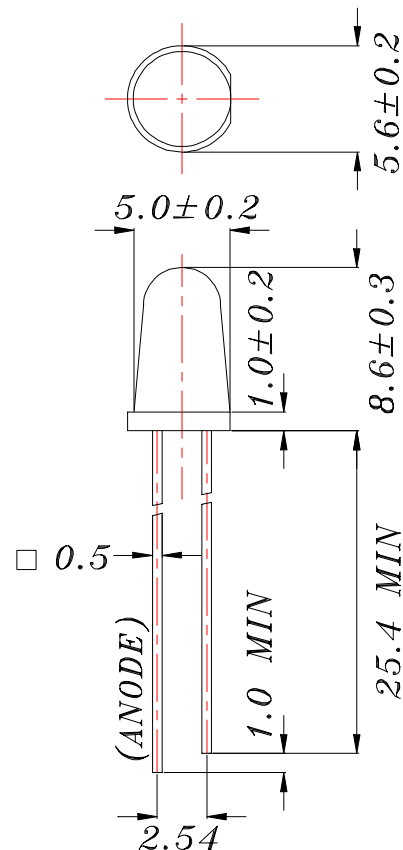

■ Notes :

1. All dimensions are in millimeters.
2. An epoxy meniscus may extend about 1.5mm(0.059") down to the lead.
3. Tolerances unless Dimension ±0.25mm.

PART NO.	Chip		Lens Color
	Material	Emitted Color	
383-2USOC/S400-A4	AlGaInP	Super Sunset Orange	Water Clear

OFFICE : NO. 25,Lane 76,Sec.3, Chung Yang Rd., Tucheng 236, Taipei, Taiwan, R.O.C.

TEL. : 886-2-2267-2000,2267-9936

FAX : 886-2-2267-6244,22676189,22676306

<http://www.everlight.com>



EVERLIGHT ELECTRONICS CO.,LTD.

Device Number : CDLE-038-032 REV.: 3

5.0mm Round Type LED Lamps

PART NO. : 383-2USOC/S400-A4 ECN : Page: 2/4

■ Absolute Maximum Ratings at Ta = 25°C

Parameter	Symbol	Rating	Unit
Forward Current	I _F	50	mA
Operating Temperature	T _{opr}	-40 to +85	°C
Storage Temperature	T _{stg}	-40 to +100	°C
Soldering Temperature	T _{sol}	260 ± 5	°C
Electrostatic Discharge	ESD	2000	V
Power Dissipation	P _d	120	mW
Peak Forward Current(Duty 1/10 @ 1KHz)	I _F (Peak)	200	mA
Reverse Voltage	V _R	5	V

■ Electronic Optical Characteristics :

Parameter	Symbol	Min.	Typ.	Max.	Unit	Condition
Luminous Intensity	I _v	4521	6782	/	mcd	I _F = 20 mA
Viewing Angle	2θ 1/2	/	6	/	deg	I _F = 20 mA
Peak Wavelength	λ _p	/	621	/	nm	I _F = 20 mA
Dominant Wavelength	λ _d	/	615	/	nm	I _F = 20 mA
Spectrum Radiation Bandwidth	Δλ	/	18	/	nm	I _F = 20 mA
Forward Voltage	V _F	/	2.0	2.4	V	I _F = 20 mA
Reverse Current	I _R	/	/	10	μA	V _R = 5 V



5.0mm Round Type LED Lamps

■ Typical Electro-Optical Characteristic Curves:

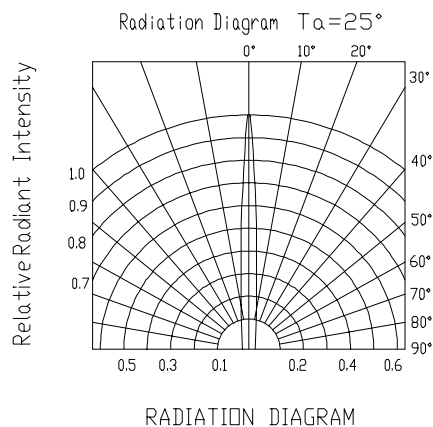
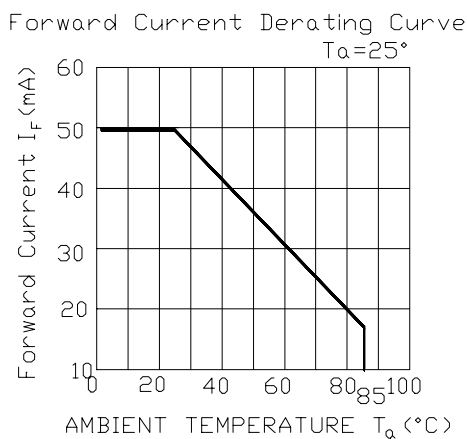
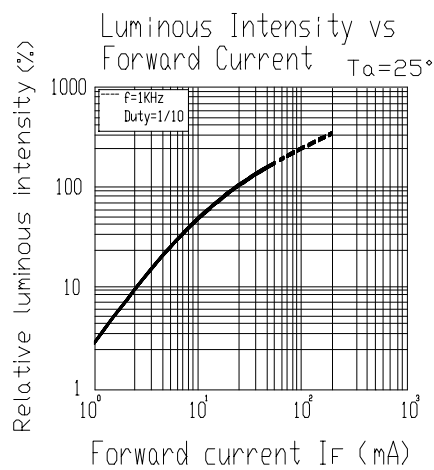
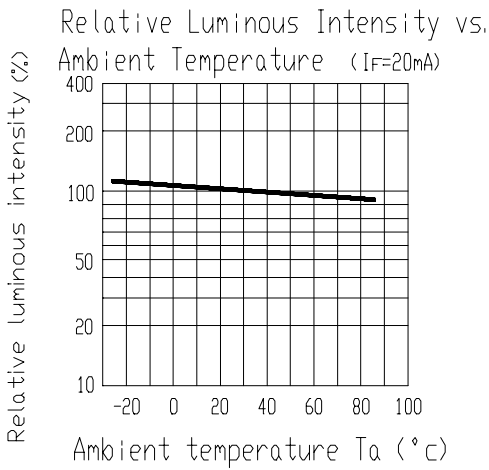
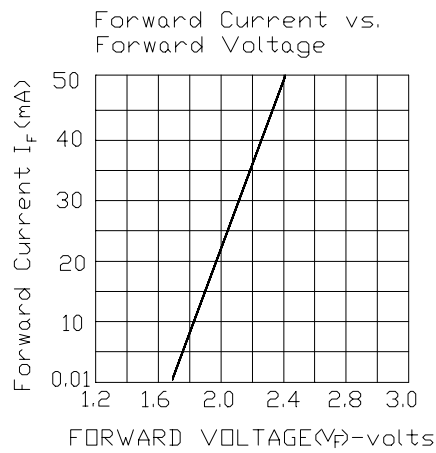
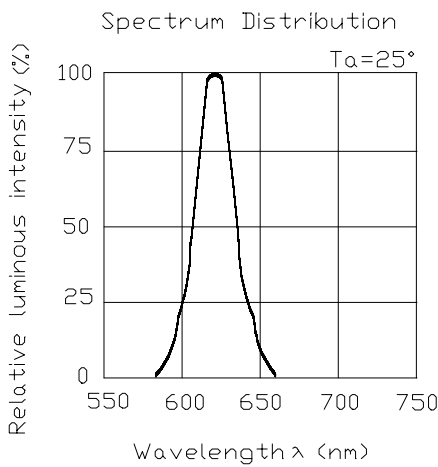



EVERLIGHT ELECTRONICS CO.,LTD.

Device Number : CDLE-038-032 REV.: 3

5.0mm Round Type LED Lamps

PART NO. : 383-2USOC/S400-A4 ECN : _____ Page: 4/4

■ Reliability test items and conditions:

No	Item	Test Conditions	Test Hours/Cycle	Sample Size	Ac/Re
1	Solder Heat	TEMP : 260°C ± 5 °C	5 SEC	76 PCS	0/1
2	Temperature Cycle	H : +85°C 30min ∫ 5 min L : -55°C 30min	50 CYCLES	76 PCS	0/1
3	Thermal Shock	H : +100°C 5min ∫ 10 sec L : -10°C 5min	50 CYCLES	76 PCS	0/1
4	High Temperature Storage	TEMP : 100°C	1000 HRS	76 PCS	0/1
5	Low Temperature Storage	TEMP : -55°C	1000 HRS	76 PCS	0/1
6	DC Operating Life	IF = 20 mA	1000 HRS	76 PCS	0/1
7	High Temperature / High Humidity	85°C /85% RH	1000 HRS	76 PCS	0/1