

Metallized Polyester (PET) Capacitors PCM 7.5 mm to 37.5 mm

Special Features

- High volume/capacitance ratio
- Self-healing
- According to RoHS 2002/95/EC

Typical Applications

For general DC-applications e.g.

- By-pass
- Blocking
- Coupling and decoupling
- Timing

Construction

Dielectric:

Polyethylene-terephthalate (PET) film

Capacitor electrodes:

Vacuum-deposited

Internal construction:

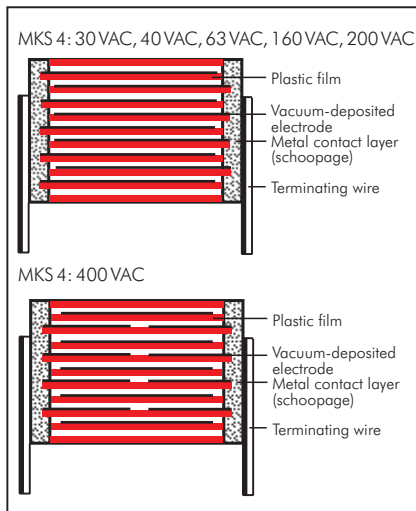

Encapsulation:

Solvent-resistant, flame-retardent plastic case with epoxy resin seal, UL 94 V-0

Terminations:

Tinned wire.

Marking:

Colour: Red. Marking: Black.
Epoxy resin seal: Red

Electrical Data

Capacitance range:

1000 pF to 220 μ F (E12-values on request)

Rated voltages:

50 VDC, 63 VDC, 100 VDC, 250 VDC, 400 VDC, 630 VDC, 1000 VDC, 1500 VDC, 2000 VDC

Capacitance tolerances:

$\pm 20\%$, $\pm 10\%$ $\pm 5\%$

Operating temperature range:

-55° C to $+100^{\circ}$ C

Climatic test category:

55/100/56 in accordance with IEC

Insulation resistance at $+20^{\circ}$ C:

U_r	U_{test}	$C \leq 0.33 \mu F$	$0.33 \mu F < C \leq 220 \mu F$
50 VDC	10V	$\geq 5 \times 10^3 M\Omega$ (mean value: $3 \times 10^4 M\Omega$)	≥ 1500 sec ($M\Omega \times \mu F$) (mean value: 4500 sec)
63 VDC	50V	$\geq 1 \times 10^4 M\Omega$ (mean value: $5 \times 10^4 M\Omega$)	≥ 3000 sec ($M\Omega \times \mu F$) (mean value: 6000 sec)
100 VDC	100V	$\geq 1.5 \times 10^4 M\Omega$ (mean value: $5 \times 10^4 M\Omega$)	≥ 5000 sec ($M\Omega \times \mu F$) (mean value: 15000 sec)
≥ 250 VDC	100V	$\geq 3 \times 10^4 M\Omega$ (mean value: $1 \times 10^5 M\Omega$)	≥ 10000 sec ($M\Omega \times \mu F$) (mean value: 40000 sec)

Measuring time: 1 min.

Dissipation factors at $+20^{\circ}$ C: $\tan \delta$

at f	$C \leq 0.1 \mu F$	$0.1 \mu F < C \leq 1.0 \mu F$	$C > 1.0 \mu F$
1 kHz	$\leq 8 \times 10^{-3}$	$\leq 8 \times 10^{-3}$	$\leq 10 \times 10^{-3}$
10 kHz	$\leq 15 \times 10^{-3}$	$\leq 15 \times 10^{-3}$	-
100 kHz	$\leq 30 \times 10^{-3}$	-	-

Maximum pulse rise time:

Capacitance pF/ μF	Pulse rise time V/ μ sec max. operation/test									
	50VDC	63VDC	100VDC	250VDC	400VDC	630VDC	1000VDC	1500VDC	2000VDC	
1000 ... 6800	-	-	-	-	-	-	70/700	90/900	100/1000	
0.01 ... 0.022	-	30/300	30/300	35/350	38/380	40/400	50/500	50/500	60/600	
0.033 ... 0.068	-	15/150	15/150	20/200	25/250	32/320	26/260	35/350	40/400	
0.1 ... 0.22	10/100	10/100	12/120	15/150	15/150	17/170	20/200	35/350	40/400	
0.33 ... 0.68	9/90	9/90	9/90	10/100	10/100	13/130	20/200	20/200	38/380	
1.0 ... 2.2	6/60	6/60	5/50	6/60	9/90	13/130	14/140	15/150	-	
3.3 ... 6.8	2.5/25	3/30	3/30	6/60	6/60	9/90	12/120	-	-	
10 ... 220	2.5/25	2.5/25	2.5/25	3/30	6/60	-	-	-	-	

for pulses equal to the rated voltage

Mechanical Tests

Pull test on leads:

$d \leq 0.8 \phi$: 10 N in direction of leads
 $d > 0.8 \phi$: 20 N in direction of leads
according to IEC 60068-2-21

Vibration:

6 hours at 10...2000 Hz and 0.75 mm displacement amplitude or 10 g in accordance with IEC 60068-2-6

Low air density:

1kPa = 10 mbar in accordance with IEC 60068-2-13

Bump test: 4000 bumps at 390 m/sec² in accordance with IEC 60068-2-29

Packing

Available taped and reeled up to and including case size 15 x 26 x 31.5 / PCM 27.5 mm.

Detailed taping information and graphs at the end of the catalogue.

For further details and graphs please refer to Technical Information.

Continuation

General Data

Capacitance	50 VDC/30 VAC*				63 VDC/40 VAC*				100 VDC/63 VAC*				250 VDC/160 VAC*				400 VDC/200 VAC*					
	W	H	L	PCM**	W	H	L	PCM**	W	H	L	PCM**	W	H	L	PCM**	W	H	L	PCM**		
0.01 µF					2.5	7	10	7.5*	2.5	7	10	7.5*	3	8.5	10	7.5*	3	8.5	10	7.5*		
0.015 "					4	9	13	10*	4	9	13	10*	4	9	13	10*	4	9	13	10*		
0.022 "					2.5	7	10	7.5*	2.5	7	10	7.5*	3	8.5	10	7.5*	3	8.5	10	7.5*		
0.033 "					4	9	13	10*	4	9	13	10*	4	9	13	10*	4	9	13	10*		
0.047 "					2.5	7	10	7.5*	2.5	7	10	7.5*	3	8.5	10	7.5*	4	9	10	7.5*		
0.068 "					4	9	13	10*	4	9	13	10*	4	9	13	10*	4	9	13	10*		
0.1 µF	2.5	7	10	7.5	2.5	7	10	7.5*	2.5	7	10	7.5*	4	9	10	7.5*	5	10.5	10.3	7.5*		
0.15 "	2.5	7	10	7.5	4	9	13	10*	4	9	13	10*	4	9	13	10*	5	11	13	10*		
0.22 "	2.5	7	10	7.5	2.5	7	10	7.5*	3	8.5	10	7.5*	5	10.5	10.3	7.5*	5.7	12.5	10.3	7.5*		
0.33 "	2.5	7	10	7.5	4	9	13	10*	4	9	13	10*	4	9	13	10*	6	12	13	10*		
0.47 "	3	8.5	10	7.5	3	8.5	10	7.5*	3	8.5	10	7.5*	5	11	13	10*	6	12.5	18	15*		
0.68 "	4	9	10	7.5	4	9	13	10*	4	9	13	10*	5	11	13	10*	6	12.5	18	15*		
1.0 µF	4	9	10	7.5	4	9	13	10*	4	9	13	10*	5.7	12.5	10.3	7.5*	8	15	18	15*		
1.5 "	5	10.5	10.3	7.5	5	11	13	10*	5	11	13	10*	6	15	26.5	22.5*	10.5	19	26.5	22.5*		
2.2 "	5.7	12.5	10.3	7.5	5.7	12.5	10.3	7.5*	6	12	13	10*	6	15	18	15*	11	21	31.5	27.5*		
3.3 "	5.7	12.5	10.3	7.5	6	12.5	18	15*	6	12	13	10*	7	14	18	15*	11	21	31.5	27.5*		
4.7 "	7.2	12.5	10.3	7.5*	6	12	13	10*	7	14	18	15*	8	15	18	15*	10.5	19	26.5	22.5*		
6.8 "	6	12	13	10*	7	14	18	15*	7	14	18	15*	9	19	31.5	27.5*	11	21	31.5	27.5*		
10 µF	9	16	18	15	8	15	18	15*	8	15	18	15*	10.5	19	26.5	22.5*	13	24	31.5	27.5		
15 "	11	21	26.5	22.5	10*	6	15	26.5	22.5*	10*	6	15	26.5	22.5*	11	21	31.5	27.5*	15	26	31.5	27.5
22 "	11	21	31.5	27.5	11	21	31.5	27.5*	11	21	31.5	27.5*	11	21	31.5	27.5*	13	24	31.5	27.5		
33 "	13	24	31.5	27.5	13	24	31.5	27.5	13	24	31.5	27.5	13	24	31.5	27.5	15	26	31.5	27.5		
47 "	15	26	31.5	27.5*	15	26	31.5	27.5	15	26	31.5	27.5	15	26	31.5	27.5	17	29	31.5	27.5		
68 "	13	24	41.5	37.5*	17	29	31.5	27.5*	17	29	31.5	27.5*	17	29	31.5	27.5*	17	29	31.5	27.5		
100 µF	19	32	41.5	37.5	17	29	41.5	37.5*	17	29	41.5	37.5*	17	29	41.5	37.5	17	29	41.5	37.5		
150 "	20	39.5	41.5	37.5	20	39.5	41.5	37.5	20	39.5	41.5	37.5	20	39.5	41.5	37.5	20	39.5	41.5	37.5		
220 "	24	45.5	41.5	37.5	24	45.5	41.5	37.5	24	45.5	41.5	37.5	24	45.5	41.5	37.5	24	45.5	41.5	37.5		

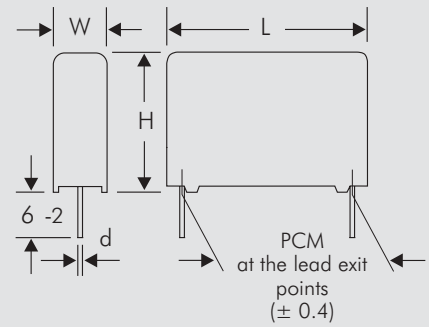

* AC voltage: $f = 50 \text{ Hz}$; $1.4 \times U_{\text{rms}} + U_{\text{DC}} \leq U_r$

** PCM = Printed circuit module = lead spacing

* On ordering please state the required PCM (lead spacing)!
If not specified, smaller PCM will be booked.

Dims. in mm.

Taped version see page 104.

Rights reserved to amend design data without prior notification.

∅ d	PCM	W
0.5	7.5	≤ 3
0.6	7.5	≥ 4
0.6	10	
0.8	15 - 27.5	
1.0	37.5	

Continuation

General Data

Capacitance	630 VDC/400 VAC*				1000 VDC/400 VAC*				1500 VDC/400 VAC*				2000 VDC/400 VAC*			
	W	H	L	PCM**	W	H	L	PCM**	W	H	L	PCM**	W	H	L	PCM**
1000 pF					3	8.5	10	7.5*	4	9	13	10	4	9	13	10
1500 "					3	8.5	10	7.5*	4	9	13	10	4	9	13	10
2200 "					3	8.5	10	7.5*	4	9	13	10	5	11	13	10
3300 "					4	9	10	7.5*	4	9	13	10	6	12	13	10*
4700 "					4	9	13	10*	4	9	13	10*	5	11	18	15*
6800 "					4	9	10	7.5*	4	9	13	10*	5	11	18	15
					4	9	13	10*	5	11	18	15*	5	11	18	15*
0.01 µF	3	8.5	10	7.5**	5	10.5	10.3	7.5*	6	12	13	10*	7	14	18	15*
0.015 "	4	9	13	10*	5	11	13	10*	5	11	18	15*	6	15	26.5	22.5*
0.022 "	4	9	13	10*	5.7	12.5	10.3	7.5*	6	12.5	18	15	6	15	26.5	22.5
0.033 "	4.5	9.5	10.3	7.5**	6	12	13	10*	6	12	13	10*	7	16.5	26.5	22.5
0.047 "	5	10.5	10.3	7.5**	5	11	18	15	7	14	18	15*	7	16.5	26.5	22.5
0.068 "	5	11	13	10*	6	15	26.5	22.5*	6	15	26.5	22.5*	6	15	26.5	22.5*
	5.7	12.5	10.3	7.5**	6	15	26.5	22.5*	6	15	26.5	22.5*	6	15	26.5	22.5*
	6	12	13	10*	7	14	18	15*	7	16.5	26.5	22.5	11	21	26.5	22.5*
	6	12	13	10*	6	15	26.5	22.5*	8.5	18.5	26.5	22.5	11	21	31.5	27.5*
	5	11	18	15*	6	15	26.5	22.5*	8.5	18.5	26.5	22.5	11	21	31.5	27.5
0.1 µF	6	12.5	18	15*	9	16	18	15*	10.5	19	26.5	22.5*	13	24	31.5	27.5
0.15 "	6	15	26.5	22.5*	7	16.5	26.5	22.5*	9	19	31.5	27.5*	13	24	31.5	27.5
0.22 "	7	14	18	15*	8.5	18.5	26.5	22.5	11	21	31.5	27.5	17	29	31.5	27.5*
0.33 "	6	15	26.5	22.5*	10.5	19	26.5	22.5	13	24	31.5	27.5	13	24	41.5	37.5*
0.47 "	8	15	18	15*	10.5	19	26.5	22.5	13	24	31.5	27.5	17	29	41.5	37.5
0.68 "	6	15	26.5	22.5*	11	21	26.5	22.5*	17	34.5	31.5	27.5*	20	39.5	41.5	37.5
	7	16.5	26.5	22.5*	11	21	31.5	27.5*	17	29	41.5	37.5*	20	39.5	41.5	37.5
	9	19	31.5	27.5*	11	21	31.5	27.5*	17	29	41.5	37.5*	20	39.5	41.5	37.5
	10.5	19	26.5	22.5*	13	24	31.5	27.5	20	39.5	31.5	27.5*	24	45.5	41.5	37.5
	9	19	31.5	27.5*	15	26	31.5	27.5	17	29	41.5	37.5*	24	45.5	41.5	37.5
	11	21	26.5	22.5*	15	26	31.5	27.5	20	39.5	41.5	37.5	24	45.5	41.5	37.5
	11	21	31.5	27.5*	15	26	31.5	27.5	20	39.5	41.5	37.5	24	45.5	41.5	37.5
1.0 µF	11	21	31.5	27.5	17	29	31.5	27.5*	24	45.5	41.5	37.5				
1.5 "	15	26	31.5	27.5	17	29	41.5	37.5*								
2.2 "	17	34.5	31.5	27.5*	19	32	41.5	37.5								
3.3 "	15	26	41.5	37.5*	20	39.5	41.5	37.5								
4.7 "	20	39.5	31.5	27.5*	24	45.5	41.5	37.5								
6.8 "	19	32	41.5	37.5*												
	20	39.5	41.5	37.5												
	24	45.5	41.5	37.5												

* AC voltage: $f = 50 \text{ Hz}$; $1.4 \times U_{\text{rms}} + U_{\text{DC}} \leq U_r$

** PCM = Printed circuit module = lead spacing

* On ordering please state the required PCM (lead spacing)!
If not specified, smaller PCM will be booked.

** Admissible AC voltage 250 VAC max.

Dims. in mm.

Taped version see page 104.

∅ d	PCM	W
0.5	7.5	≤ 3
0.6	7.5	≥ 4
0.6	10	
0.8	15 - 27.5	
1.0	37.5	

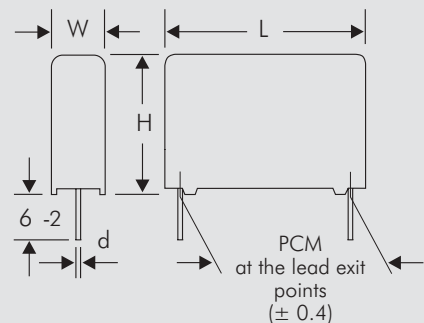

Rights reserved to amend design data without prior notification.

WIMA MKP 4



Continuation

Permissible AC voltage in relation to frequency at 10° C internal temperature rise (general guide).

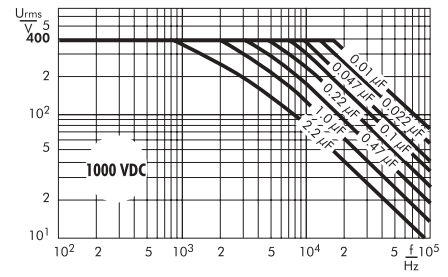
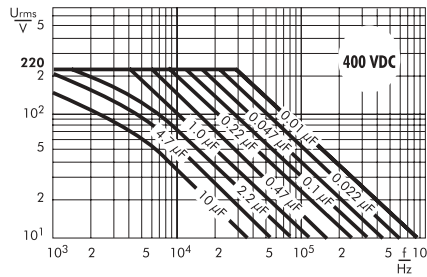
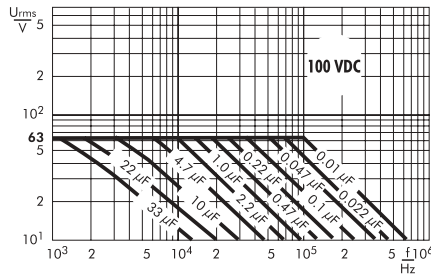
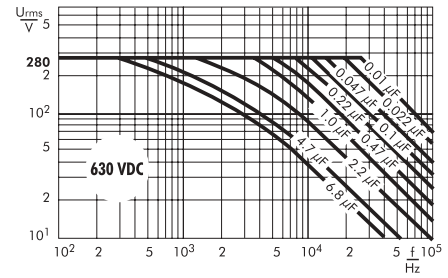
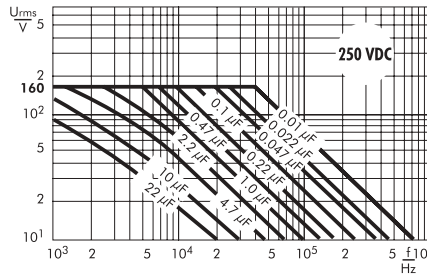

WIMA MKS 4

Permissible AC voltage in relation to frequency at 10° C internal temperature rise (general guide).

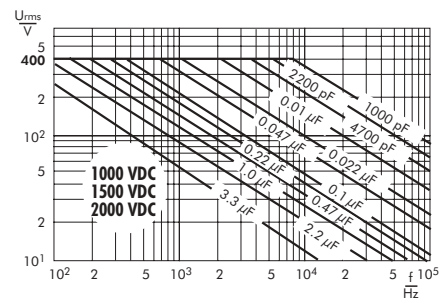
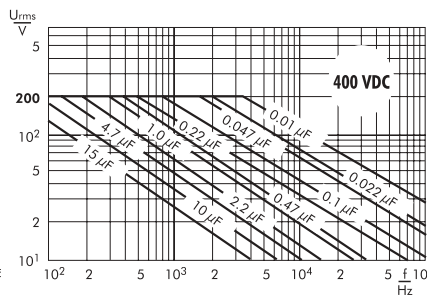
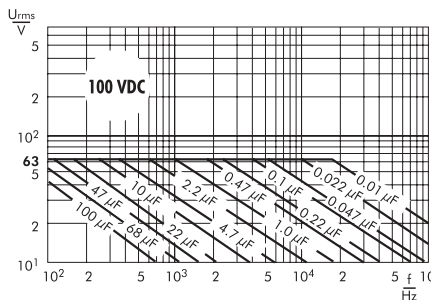
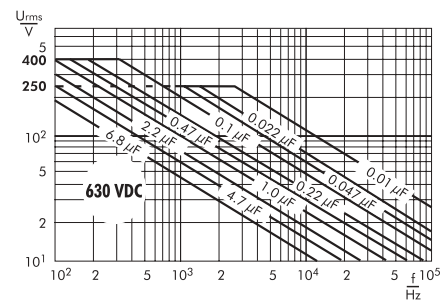
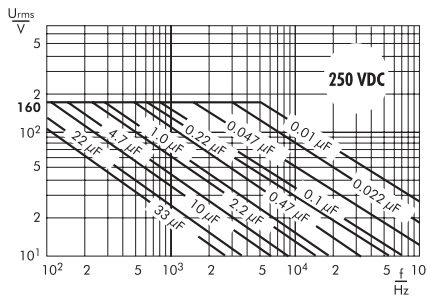
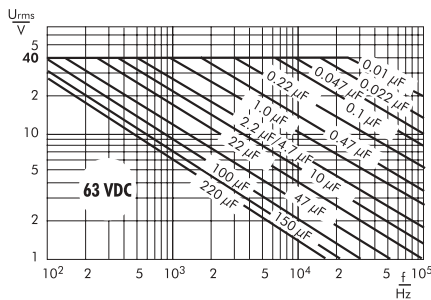

Technical information and general data see page 57.

Recommendation for Processing and Application of Through-Hole Capacitors

Soldering Process

A preheating of through-hole WIMA capacitors is allowed for temperatures $T_{\max} < 100^{\circ}\text{C}$. In practice a preheating duration of $t < 5$ min. has been proven to be best.

Single wave soldering

Soldering bath temperature: $T < 260^{\circ}\text{C}$
Immersion time: $t < 5$ sec

Double wave soldering

Soldering bath temperature: $T < 260^{\circ}\text{C}$
Immersion time: $2 \times t < 3$ sec

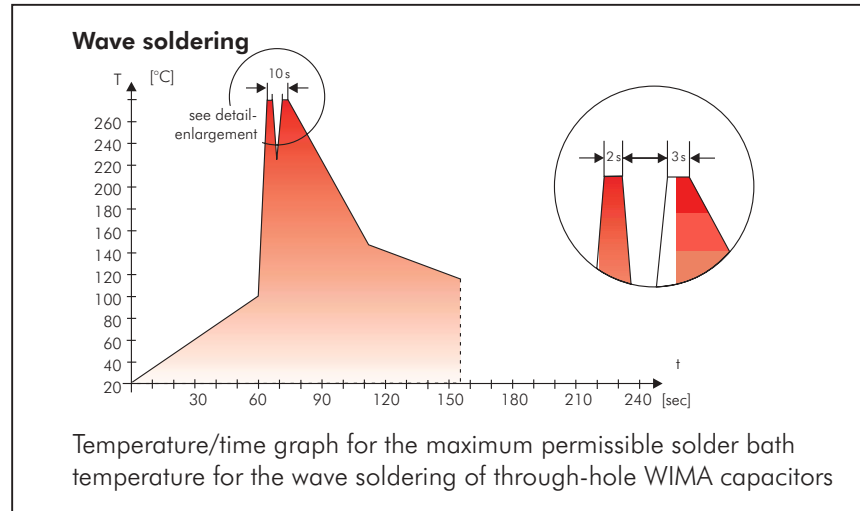

WIMA Quality and Environmental Philosophy

ISO 9001:2000 Certification

ISO 9001:2000 is an international basic standard of quality assurance systems for all branches of industry. The approval according to ISO 9001:2000 of our factories by the VDE inspectorate certifies that organisation, equipment and monitoring of quality assurance in our factories correspond to internationally recognized standards.

WIMA WPCS

The WIMA Process Control System (WPCS) is a quality surveillance and optimization system developed by WIMA. WPCS is a major part of the quality-oriented WIMA production. Points of application of WPCS during production process:

- incoming material inspection
- metallization
- film inspection
- schoopage
- pre-healing
- lead attachment
- cast resin preparation/encapsulation
- 100% final inspection
- AQL check

WIMA Environmental Policy

All WIMA capacitors, irrespective of whether through-hole devices or SMD, are made of environmentally friendly materials. Neither during manufacture nor in the product itself any toxic substances are used, e.g.

- Lead
- PCB
- CFC
- Hydrocarbon chloride
- Chromium 6+
- PBB/PBDE
- Arsenic
- Cadmium
- Mercury
- etc.

We merely use pure, recyclable materials for packing our components, such as:

- carton
- cardboard
- adhesive tape made of paper
- polystyrene

We almost completely refrain from using packing materials such as:

- foamed polystyrene (Styropor®)
- adhesive tapes made of plastic
- metal clips

RoHS Compliance

According to the RoHS Directive 2002/95/EC certain hazardous substances like e.g. lead, cadmium, mercury must not be used any longer in electronic equipment as of July 1st, 2006. For the sake of the environment WIMA has refrained from using such substances since years already.



WIMA Kondensatoren sind bleifrei konform RoHS 2002/95/EG

WIMA capacitors are lead free in accordance with RoHS 2002/95/EC

Tape for lead-free WIMA capacitors

DIN EN ISO 14001:2005

WIMA's environmental management has been established in accordance with the guidelines of DIN EN ISO 14001:2005. The certification has been granted in June 2006.

Typical Dimensions for Taping Configuration

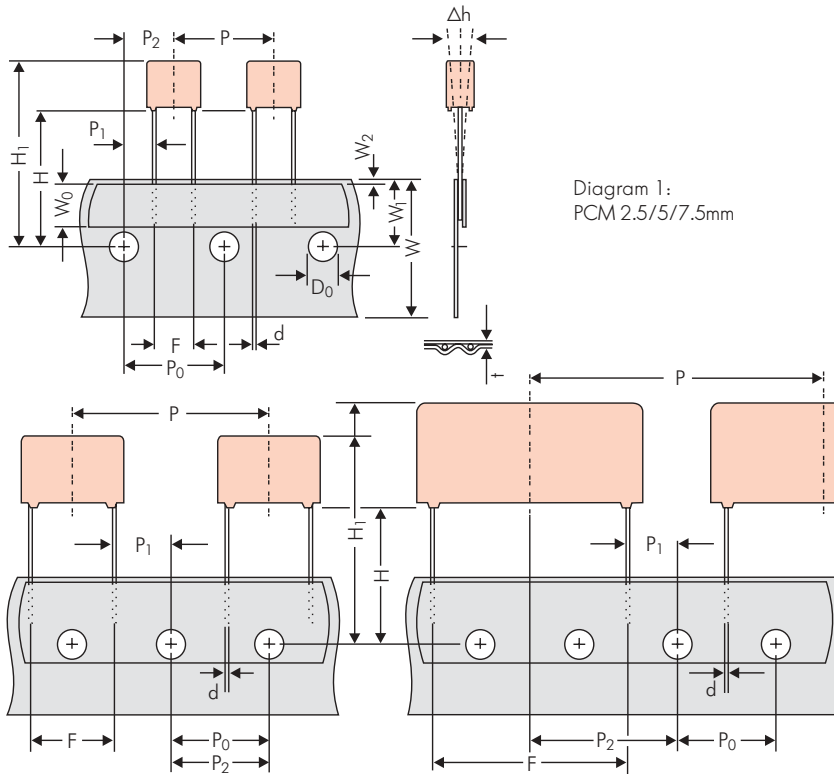

Diagram 2: PCM 10/15 mm

Diagram 3: PCM 22.5 and 27.5*mm

*PCM 27.5 tapping possible with two feed holes between components

Designation	Symbol	Dimensions for Radial Taping						
		PCM 2.5 tapping	PCM 5 tapping	PCM 7.5 tapping	PCM 10 tapping*	PCM 15 tapping*	PCM 22.5 tapping	PCM 27.5 tapping
Carrier tape width	W	18.0 ±0.5	18.0 ±0.5	18.0 ±0.5	18.0 ±0.5	18.0 ±0.5	18.0 ±0.5	18.0 ±0.5
Hold-down tape width	W ₀	6.0 for hot-sealing adhesive tape	6.0 for hot-sealing adhesive tape	12.0 for hot-sealing adhesive tape	12.0 for hot-sealing adhesive tape	12.0 for hot-sealing adhesive tape	12.0 for hot-sealing adhesive tape	12.0 for hot-sealing adhesive tape
Hole position	W ₁	9.0 ±0.5	9.0 ±0.5	9.0 ±0.5	9.0 ±0.5	9.0 ±0.5	9.0 ±0.5	9.0 ±0.5
Hold-down tape position	W ₂	0.5 to 3.0 max.	0.5 to 3.0 max.	0.5 to 3.0 max.	0.5 to 3.0 max.	0.5 to 3.0 max.	0.5 to 3.0 max.	0.5 to 3.0 max.
Feed hole diameter	D ₀	4.0 ±0.2	4.0 ±0.2	4.0 ±0.2	4.0 ±0.2	4.0 ±0.2	4.0 ±0.2	4.0 ±0.2
Pitch of component	P	12.7 ±1.0	12.7 ±1.0	12.7 ±1.0	25.4 ±1.0	25.4 ±1.0	38.1 ±1.5	38.1 ±1.5 or 50.8 ±1.5
Feed hole pitch	P ₀	12.7 ±0.3 cumulative pitch error max. 1.0 mm/20 pitch	12.7 ±0.3 cumulative pitch error max. 1.0 mm/20 pitch	12.7 ±0.3 cumulative pitch error max. 1.0 mm/20 pitch	12.7 ±0.3 cumulative pitch error max. 1.0 mm/20 pitch	12.7 ±0.3 cumulative pitch error max. 1.0 mm/20 pitch	12.7 ±0.3 cumulative pitch error max. 1.0 mm/20 pitch	12.7 ±0.3 cumulative pitch error max. 1.0 mm/20 pitch
Feed hole centre to lead	P ₁	5.1 ±0.5	3.85 ±0.7	2.6 ±0.7	7.7 ±0.7	5.2 ±0.7	7.8 ±0.7	5.3 ±0.7
Hole centre to component centre	P ₂	6.35 ±1.3	6.35 ±1.3	6.35 ±1.3	12.7 ±1.3	12.7 ±1.3	19.05 ±1.3	19.05 ±1.3
Feed hole centre to bottom edge of the component	H _▲	16.5 ±0.3 18.5 ±0.5	16.5 ±0.3 18.5 ±0.5	16.5 ±0.5 18.5 ±0.5	16.5 ±0.5 18.5 ±0.5	16.5 ±0.5 18.5 ±0.5	16.5 ±0.5 18.5 ±0.5	16.5 ±0.5 18.5 ±0.5
Feed hole centre to top edge of the component	H ₁	H+H _{component} < H ₁ 32.25 max.	H+H _{component} < H ₁ 32.25 max.	H+H _{component} < H ₁ 24.5 to 31.5	H+H _{component} < H ₁ 25.0 to 31.5	H+H _{component} < H ₁ 26.0 to 37.0	H+H _{component} < H ₁ 30.0 to 43.0	H+H _{component} < H ₁ 35.0 to 45.0
Lead spacing at upper edge of carrier tape	F	2.5 ±0.5	5.0 ^{+0.8} _{-0.2}	7.5 ±0.8	10.0 ±0.8	15 ±0.8	22.5 ±0.8	27.5 ±0.8
Lead diameter	d	0.4 ±0.05	0.5 ±0.05	0.5 ±0.05 or 0.6 ^{+0.06} _{-0.05}	0.5 ±0.05 or 0.6 ^{+0.06} _{-0.05}	0.8 ^{+0.08} _{-0.05}	0.8 ^{+0.08} _{-0.05}	0.8 ^{+0.08} _{-0.05}
Component alignment	Δh	± 2.0 max.	± 2.0 max.	± 3.0 max.	± 3.0 max.	± 3.0 max.	± 3.0 max.	± 3.0 max.
Total tape thickness	t	0.7 ±0.2	0.7 ±0.2	0.7 ±0.2	0.7 ±0.2	0.7 ±0.2	0.7 ±0.2	0.7 ±0.2
Package (see also page 105)	▲	ROLL/AMMO			AMMO			
Unit		REEL ø 360 max. ø 30 ±1 } depending on comp. dimensions			REEL ø 360 max. ø 30 ±1 } depending on PCM and component dimensions			

- ▲ Please give „H“ dimensions and desired packaging type when ordering.
- Diameter of leads see General Data.
- * PCM 10 and PCM 15 can be crimped to PCM 7.5.

Dim's in mm.
Please clarify customer-specific deviations with the manufacturer.

Position of components according to PCM 7.5 (sketch 1). P₀ = 12.7 or 15.0 is possible